

Provided for non-commercial research and education use.  
Not for reproduction, distribution or commercial use.



This article appeared in a journal published by Elsevier. The attached copy is furnished to the author for internal non-commercial research and education use, including for instruction at the authors institution and sharing with colleagues.

Other uses, including reproduction and distribution, or selling or licensing copies, or posting to personal, institutional or third party websites are prohibited.

In most cases authors are permitted to post their version of the article (e.g. in Word or Tex form) to their personal website or institutional repository. Authors requiring further information regarding Elsevier's archiving and manuscript policies are encouraged to visit:

<http://www.elsevier.com/copyright>



ELSEVIER

Contents lists available at ScienceDirect

# Journal of Combinatorial Theory, Series A

[www.elsevier.com/locate/jcta](http://www.elsevier.com/locate/jcta)

## Extensions and restrictions of Wythoff's game preserving its $\mathcal{P}$ positions

Eric Duchêne<sup>a</sup>, Aviezri S. Fraenkel<sup>b</sup>, Richard J. Nowakowski<sup>c</sup>, Michel Rigo<sup>d</sup>

<sup>a</sup> Laboratoire LIESP, Univ. Claude Bernard Lyon 1, Bât. Nautibus (ex 710), 843, Bd. du 11 novembre 1918, 69622 Villeurbanne Cedex, France

<sup>b</sup> Department of Computer Science & Applied Mathematics, Weizmann Institute of Science, 76100 Rehovot, Israel

<sup>c</sup> Department of Mathematics and Statistics, Dalhousie University, Halifax, Nova Scotia, Canada B3H 3J5

<sup>d</sup> Institute of Mathematics, University of Liège, Grande Traverse 12 (B 37), B-4000 Liège, Belgium

### ARTICLE INFO

#### Article history:

Received 16 July 2008

Available online 21 August 2009

#### Keywords:

Combinatorial game theory

Wythoff's game

Complexity of games

Automatic sequences

Numeration systems

### ABSTRACT

We consider extensions and restrictions of Wythoff's game having exactly the same set of  $\mathcal{P}$  positions as the original game. No strict subset of rules gives the same set of  $\mathcal{P}$  positions. On the other hand, we characterize all moves that can be adjoined while preserving the original set of  $\mathcal{P}$  positions. Testing if a move belongs to such an extended set of rules is shown to be doable in polynomial time. Many arguments rely on the infinite Fibonacci word, automatic sequences and the corresponding numeration system. With these tools, we provide new two-dimensional morphisms generating an infinite picture encoding respectively  $\mathcal{P}$  positions of Wythoff's game and moves that can be adjoined.

© 2009 Elsevier Inc. All rights reserved.

## 1. Introduction

Wythoff's game is a well-known 2-player combinatorial game played on two heaps of finitely many tokens. It was introduced in [22]. Two types of moves are allowed:

- Remove any positive number of tokens from one heap (the *Nim* rule).
- Remove the same positive number of tokens from both heaps (Wythoff's rule).

The game ends when the two heaps are empty. The player making the last move wins. We denote by  $(a, b)$  a game position where  $a$  and  $b$  are the numbers of tokens in the two heaps. A position is called a  $\mathcal{P}$  position if there exists a strategy for the second player (i.e., the player who will play on the next

E-mail addresses: [educhene@bat710.univ-lyon1.fr](mailto:educhene@bat710.univ-lyon1.fr) (E. Duchêne), [aviezri.fraenkel@weizmann.ac.il](mailto:aviezri.fraenkel@weizmann.ac.il) (A.S. Fraenkel), [rjn@mathstat.dal.ca](mailto:rjn@mathstat.dal.ca) (R.J. Nowakowski), [M.Rigo@ulg.ac.be](mailto:M.Rigo@ulg.ac.be) (M. Rigo).

**Table 1**

First values of the sequences  $(A_n)_{n \geq 0}$  and  $(B_n)_{n \geq 0}$ .

$n$	0	1	2	3	4	5	6	7	8	9	10	11	12	13	14	15
$A_n$	0	1	3	4	6	8	9	11	12	14	16	17	19	21	22	24
$B_n$	0	2	5	7	10	13	15	18	20	23	26	28	31	34	36	39

round) to win the game, whatever the move of the first player is. It is an  $\mathcal{N}$  position if there exists a winning strategy for the first player (i.e., the one who is making the actual move). As a consequence of the next proposition, it turns out that each game position is either  $\mathcal{P}$  or  $\mathcal{N}$  (details about impartial acyclic games can be found in [2]).

**Proposition 1** (Characterization of the  $\mathcal{P}$  positions of an impartial acyclic game). *The sets of  $\mathcal{P}$  and  $\mathcal{N}$  positions of any impartial acyclic game (like Wythoff's game) are uniquely determined by the following two properties:*

- Any move from a  $\mathcal{P}$  position leads to an  $\mathcal{N}$  position (stability property of the  $\mathcal{P}$  positions).
- From any  $\mathcal{N}$  position, there exists a move leading to a  $\mathcal{P}$  position (absorbing property of the  $\mathcal{P}$  positions).

Symmetry of the game rules implies that  $(a, b)$  is a  $\mathcal{P}$  position if and only if  $(b, a)$  is also a  $\mathcal{P}$  position. We will denote by  $(A_n, B_n)$  the  $n$ th  $\mathcal{P}$  position of Wythoff's game, with  $0 \leq A_n \leq B_n$ . We set  $(A_0, B_0) = (0, 0)$ , since from this position with two empty heaps the first player cannot move, so the second wins by default. In the literature, the sequence  $(A_n, B_n)_{n \geq 0}$  is called *Wythoff's sequence*. Table 1 contains its first values. A recursive characterization of the sequence is recalled in Proposition 2.

**Proposition 2** (Recursive characterization of Wythoff's sequence). (See [22].) *For all  $n \geq 0$ , we have*

$$A_n = \text{Mex}(\{A_i, B_i : 0 \leq i < n\}),$$

$$B_n = A_n + n,$$

where  $\text{Mex}(U)$  stands for Minimum EXcluded value of  $U \subset \mathbb{N}$  (with  $U \neq \mathbb{N}$ ), i.e., the smallest nonnegative integer not in  $U$  (see [2]). The proposition below follows easily from Proposition 2.

**Proposition 3.** *The sets  $\{A_n : n \geq 1\}$  and  $\{B_n : n \geq 1\}$  partition  $\mathbb{N}_{\geq 1}$ .*

The characterization of Wythoff's sequence described in Proposition 2 does not permit to decide in polynomial time whether or not a given game position  $(a, b)$  is a  $\mathcal{P}$  position. As explained in [10], this decision problem is crucial in "game complexity" theory. Therefore a polynomial time procedure based on the following algebraic characterization is given in [22].

**Proposition 4** (Algebraic characterization of Wythoff's sequence). *For all  $n \geq 0$ , we have*

$$A_n = \lfloor n\tau \rfloor,$$

$$B_n = \lfloor n\tau^2 \rfloor = \lfloor n\tau \rfloor + n,$$

where  $\tau$  is the golden ratio  $(1 + \sqrt{5})/2$ .

Let us now briefly present the content of this paper. In Section 2, we provide three polynomial-time characterizations of Wythoff's sequence. The first one derives from the Fibonacci word and focuses on combinatorics on words. The extensive use of combinatorics on words to deal with games appears recently in [8]. The Fibonacci word was also used by A. Fink to solve a major conjecture about the 2-player game Toppling Dominoes [9]. The second characterization is an arithmetic one coming unsurprisingly from the Fibonacci numeration system. As for the algebraic characterization,

it permits to decide in polynomial time whether or not a game position is a  $\mathcal{P}$  position. This point of view is detailed in [13]. The third characterization is original and stems from a two-dimensional morphic approach. We are able to build the two-dimensional (infinite) table containing the  $\mathcal{P}$  and the  $\mathcal{N}$  positions of Wythoff's game as the projection by a coding of the fixed point of a two-dimensional morphism over a finite alphabet. We also give in Section 2 several lemmas linked to combinatorics on words and numeration systems that are used in the sequel of this paper.

In many papers devoted to variations of Wythoff's game, new rules are adjoined to the original ones. Such variations are called *extensions*. As an example, in [13] Wythoff's rule is relaxed to take  $k > 0$  tokens from one pile,  $\ell > 0$  from the other, subject to  $|k - \ell| < s$  where  $s > 0$  is a fixed integer parameter. Other examples of extensions of Wythoff's game are given in [5,11,12,15]. There are a few papers where only subsets of Wythoff's moves are allowed (see [6,7,14] for examples). Such variations are called *restrictions* of Wythoff's game. For all these extensions and restrictions of Wythoff's game, the main goal is to find characterizations of the sequence of  $\mathcal{P}$  positions, which almost always differs from the original Wythoff's sequence.

In the present paper, we also consider extensions (Section 3) and restrictions (Section 4) of Wythoff's game. The main new ingredient in the present work is the preservation of the  $\mathcal{P}$  positions of Wythoff's game. Moreover in Section 3, the moves that we add in our extensions need to be playable **from any game position**, as is the case for Wythoff's game. Indeed, we could have imagined games where this property does not hold: for example we remove an odd number of tokens from a position  $(a, b)$  if  $a$  or  $b$  is a prime number, and an even number of tokens otherwise.

We characterize below all the sets of moves that can be adjoined to Wythoff's rules while preserving the sequence of  $\mathcal{P}$  positions, under the condition assumed in the previous paragraph, i.e., all the adjoined moves are playable from any game position. The complexity of this characterization is an important issue and is investigated in Section 3. To decide whether or not a move can be adjoined to Wythoff's game without changing the sequence of  $\mathcal{P}$  positions, it suffices to check that it does not change the stability property (defined in Proposition 1). Indeed, adding a move leading from some  $\mathcal{P}$  position to another  $\mathcal{P}$  position would necessarily change the stability property of the  $\mathcal{P}$  positions (by Proposition 1). On the other hand, adding a move which does not correspond to a move between any two  $\mathcal{P}$  positions means that both properties of Proposition 1 remain true. Therefore, a move  $(i, j)$  can be added if and only if it prevents a move from a  $\mathcal{P}$  position to another  $\mathcal{P}$  position of Wythoff's game. In other words, a necessary and sufficient condition for a move  $(i, j)_{i < j}$  to be adjoined is that it does not belong to

$$\{(A_n - A_m, B_n - B_m): n > m \geq 0\} \cup \{(A_n - B_m, B_n - A_m): n > m \geq 0\}.$$

By Proposition 4, this condition can be restated as follows.

**Proposition 5.** *A move  $(i, j)_{i < j}$  can be adjoined to Wythoff's rules without changing the sequence of the  $\mathcal{P}$  positions if and only if it satisfies*

$$(i, j) \neq (\lfloor n\tau \rfloor - \lfloor m\tau \rfloor, \lfloor n\tau^2 \rfloor - \lfloor m\tau^2 \rfloor) \quad \forall n > m \geq 0 \tag{1}$$

and

$$(i, j) \neq (\lfloor n\tau \rfloor - \lfloor m\tau^2 \rfloor, \lfloor n\tau^2 \rfloor - \lfloor m\tau \rfloor) \quad \forall n > m \geq 0. \tag{2}$$

So Proposition 5 answers our initial question about the characterization of “adjoinable” moves preserving Wythoff's sequence as a set of  $\mathcal{P}$  positions. However, the original Wythoff's game has the property that one can decide in polynomial time whether or not a given move belongs to the set of rules. This property appears to be a necessary condition for a game to be *polynomial* or *tractable* (see [10] for details). Therefore we discuss in Section 3 the complexity of this decision problem for the moves described in Proposition 5. We obtain polynomial complexity using the Fibonacci numeration system. Note that though the moves we adjoin preserve the  $\mathcal{P}$  positions, they do not preserve the nonzero values of the Sprague–Grundy function.

Finally, we show in Section 4 that there is no restriction of Wythoff's game preserving Wythoff's set of  $\mathcal{P}$  positions.

## 2. Characterizations of Wythoff's sequence

This section has been written for a game theoretician reader with no particular knowledge in formal languages theory nor combinatorics on words. We recall all the necessary material about words, morphisms and automatic sequences. Our main aim is to obtain a morphism generating a two-dimensional (infinite) table encoding  $\mathcal{N}$  and  $\mathcal{P}$  positions of Wythoff's game, the so-called *Wythoff's matrix*. We recall in the first subsection that Wythoff's sequence can be derived from the Fibonacci morphism. Morphisms are naturally associated with automata and numeration systems. In the second subsection, we derive a characterization of the Wythoff's sequence from representations in the Fibonacci numeration system. Finally, the third subsection discuss the two-dimensional morphic characterization of the Wythoff's matrix. We also include in this section some technical results that will be used in other sections of this paper.

### 2.1. A morphic characterization

Let  $\Sigma$  be a finite alphabet. We denote by  $\Sigma^*$  the set of finite words over  $\Sigma$  and by  $\Sigma^{\mathbb{N}}$  the set of maps from  $\mathbb{N}$  onto  $\Sigma$ . Such maps are called infinite words over  $\Sigma$ . If  $w \in \Sigma^*$  is a word and  $\sigma \in \Sigma$  is a letter,  $|w|$  (resp.  $|w|_{\sigma}$ ) denotes the length of  $w$  (resp. the number of occurrences of  $\sigma$  in  $w$ ). The unique word of length zero is the empty word  $\varepsilon$  and  $\Sigma^+ := \Sigma^* \setminus \{\varepsilon\}$ . If  $w \in \Sigma^*$  can be decomposed as  $w = xyz$  with  $x, y, z$  in  $\Sigma^*$  then  $x$  is said to be a *prefix* of  $w$  and  $y$  is said to be a *factor* (or *subword*) of  $w$ . The set  $\Sigma^*$  endowed with concatenation of words as product operation is a monoid. Let  $\varphi : \Sigma \rightarrow \Sigma^*$  be a map extended to a morphism of monoid  $\varphi : \Sigma^* \rightarrow \Sigma^*$ , i.e., for all  $u, v \in \Sigma^*$ ,  $\varphi(uv) = \varphi(u)\varphi(v)$  and  $\varphi(\varepsilon) = \varepsilon$ . Let  $a \in \Sigma$  and  $u \in \Sigma^+$  be such that  $\varphi(a) = au$ . Then for all  $n \in \mathbb{N}$ ,  $\varphi^n(a) = au\varphi(u) \cdots \varphi^{n-1}(u)$ . If moreover  $\lim_{n \rightarrow \infty} |\varphi^n(a)| = +\infty$  then the sequence  $(\varphi^n(a))_{n \geq 0}$  of finite words converges to a unique infinite word denoted  $\varphi^{\omega}(a)$  because  $\varphi^n(a)$  is a prefix of  $\varphi^{n+1}(a)$  for all  $n \geq 0$ . A morphism  $\varphi : \Sigma \rightarrow \Sigma^*$  is said to be of *constant length*, if there exists  $\ell > 0$  such that for all  $\sigma \in \Sigma$ ,  $|\varphi(\sigma)| = \ell$ . Let  $\Sigma$  and  $\Gamma$  be two alphabets (usually  $\#\Gamma < \#\Sigma$ ). A *coding* is a morphism  $\mu : \Sigma \rightarrow \Gamma^*$  such that for all  $\sigma \in \Sigma$ ,  $\mu(\sigma) \in \Gamma$ .

**Example 1** (*Fibonacci word*). Let  $\Sigma = \{a, b\}$  and  $\varphi : a \mapsto ab, b \mapsto a$ . We have  $\varphi(a) = ab$ ,  $\varphi^2(a) = \varphi(a)\varphi(b) = aba$ ,  $\varphi^3(a) = \varphi(a)\varphi(b)\varphi(a) = abaab, \dots$  thus

$$\varphi^{\omega}(a) = abaababaabaabaabaabaabaabaabaab \dots$$

This infinite word is the well-known *Fibonacci word* that will be denoted by  $\mathcal{F}$ . The Fibonacci word has many properties. It is a *Sturmian word*: for all  $n \geq 0$ , the number of distinct factors of length  $n$  is  $n + 1$  (see [18, Chapter 2] for details). In particular any Sturmian word is written over a binary alphabet  $\{a, b\}$ . If positions inside  $\mathcal{F}$  are counted from 1, then the position of the  $n$ th letter  $a$  (resp.  $b$ ) is denoted by  $A_n$  (resp.  $B_n$ ),  $n \geq 1$ . Moreover, denote by  $\mathcal{F}(n)$  the letter occurring in position  $n$  in  $\mathcal{F}$  and by  $\mathcal{F}[i \dots j]$ ,  $i < j$ , the factor  $\mathcal{F}(i)\mathcal{F}(i + 1) \cdots \mathcal{F}(j)$  of  $\mathcal{F}$ . For instance,  $A_1 = 1$ ,  $A_2 = 3$ ,  $A_3 = 4$ ,  $B_1 = 2$ ,  $B_2 = 5$ ,  $B_3 = 7$ ,  $\mathcal{F}(1) = a$ ,  $\mathcal{F}(5) = b$ , and  $\mathcal{F}[2 \dots 5] = baab$ .

In [8] the following characterization of Wythoff's sequence using the Fibonacci word is given.

**Proposition 6** (*Morphic characterization of Wythoff's sequence*). *The sequence  $(A_n, B_n)_{n \geq 1}$  defined in Example 1 is exactly the Wythoff's sequence.*

Thanks to this proposition, we can give lemmas and remarks about Wythoff's sequence and the Fibonacci word that will be used in Section 3. The following two remarks link the Fibonacci word with the gaps between consecutive  $A_i$ 's and  $B_i$ 's. In particular, we show that  $A_{n+1} - A_n \in \{1, 2\}$ , and  $B_{n+1} - B_n \in \{2, 3\}$ .

**Remark 1.** Since for any letter  $x \in \{a, b\}$ ,  $\varphi(x)$  begins with  $a$ , it is obvious that  $\Delta_n(a) := A_{n+1} - A_n$  is given by  $\psi_a(\mathcal{F}(n))$  where  $\psi_a : a \mapsto 2, b \mapsto 1$ .

**Remark 2.** Looking at  $\varphi^2(a) = aba$  and  $\varphi^2(b) = ab$ , one can see that  $b$  always occurs in second position. Since  $\varphi^2(\mathcal{F}) = \mathcal{F}$ , we get that  $\Delta_n(b) := B_{n+1} - B_n$  is given by  $\psi_b(\mathcal{F}(n))$  where  $\psi_b : a \mapsto 3, b \mapsto 2$ .

**Lemma 1.** We have  $\{B_n + 4\}_{n \geq 1} \subseteq \{A_n\}_{n \geq 1}$ .

**Proof.** Let  $i = B_n$  be the index of the  $n$ th occurrence of a letter  $b$  in  $\mathcal{F}$ . According to the morphism  $\varphi$ , the difference between two consecutive letters  $b$  in the Fibonacci word is either 2 or 3. For  $(i + 4)$  to be the index of an occurrence of another  $b$ , we need to have  $B_{n+1} - B_n = 2$  and  $B_{n+2} - B_{n+1} = 2$ . But the factor  $babab$  never appears in  $\mathcal{F}$ , since it would be produced by a factor  $aaa$ , which never occurs in view of Remark 2. Hence  $(i + 4)$  is the index of an occurrence of a letter  $a$ .  $\square$

Any Sturmian word like the Fibonacci word is *balanced*, meaning that for any two factors  $u$  and  $v$  of same length, we have  $||u|_a - |v|_a| \leq 1$ . In the next lemma, we get a little more for specific factors.

**Lemma 2.** Let  $\mathcal{F}_n$  be the prefix of  $\mathcal{F}$  of length  $n$ . For any finite factor  $bu$  occurring in the Fibonacci word  $\mathcal{F}$  with  $|u| = n$ , we have  $|u|_a = |\mathcal{F}_n|_a$  and  $|u|_b = |\mathcal{F}_n|_b$ .

**Example 2.** With  $u = aabaab$ , the factor  $bu$  of length 8 starts in  $\mathcal{F}$  from position 7. One can check that  $\mathcal{F}_6 = abaaba$  is a permutation of  $u$ :

$$\mathcal{F} = \underbrace{abaaba}_{\mathcal{F}_6} \overbrace{baabaab}^{bu} a \text{ baababaaba} \dots$$

**Proof of Lemma 2.** Since  $u$  and  $\mathcal{F}_n$  have the same length, we simply have to show that  $|u|_b = |\mathcal{F}_n|_b$ . Thanks to Proposition 4, we get

$$|\mathcal{F}_n|_b = \#\{i \geq 1 \mid \lfloor i\tau^2 \rfloor \leq n\}. \tag{3}$$

Assume that the first occurrence of  $bu$  in  $\mathcal{F}$  starts in position  $\lfloor j_0\tau^2 \rfloor$ . Again using Proposition 4 we get

$$|u|_b = \#\{i \mid \lfloor j_0\tau^2 \rfloor < \lfloor i\tau^2 \rfloor < \lfloor j_0\tau^2 \rfloor + n + 1\}.$$

Since in position  $\lfloor j_0\tau^2 \rfloor + n + 1$  there is a letter  $a$ , we know that  $\lfloor j_0\tau^2 \rfloor + n + 1$  is of the form  $\lfloor k\tau \rfloor$  for some integer  $k$  and from Proposition 3, it cannot be of the form  $\lfloor i\tau^2 \rfloor$ . Consequently, in the previous formula, we can replace the rightmost strict inequality with a large one and get

$$|u|_b = \#\{i > j_0 \mid \lfloor i\tau^2 \rfloor \leq \lfloor j_0\tau^2 \rfloor + n + 1\}.$$

Notice that  $\lfloor i\tau^2 \rfloor - \lfloor j_0\tau^2 \rfloor$  is equal to  $\lfloor (i - j_0)\tau^2 \rfloor + 1$  or  $\lfloor (i - j_0)\tau^2 \rfloor$  depending whether  $\{i\tau^2\} - \{j_0\tau^2\} < 0$  or not. In the first case, we get

$$|u|_b = \#\{i > j_0 \mid \lfloor (i - j_0)\tau^2 \rfloor + 1 \leq n + 1\} = \#\{i > j_0 \mid \lfloor (i - j_0)\tau^2 \rfloor \leq n\}$$

which is exactly (3). In the second case, we have

$$|u|_b = \#\{i > j_0 \mid \lfloor (i - j_0)\tau^2 \rfloor \leq n + 1\}$$

but since, here  $\lfloor (i - j_0)\tau^2 \rfloor = \lfloor i\tau^2 \rfloor - \lfloor j_0\tau^2 \rfloor$ , this latter quantity cannot be equal to  $n + 1$  (because there is a letter  $a$  in position  $\lfloor j_0\tau^2 \rfloor + n + 1$ ). Consequently, we have

$$|u|_b = \#\{i > j_0 \mid \lfloor (i - j_0)\tau^2 \rfloor < n + 1\}$$

which is exactly (3).  $\square$

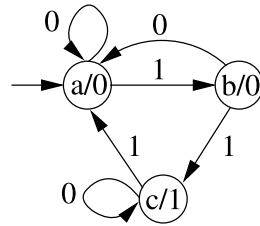

Fig. 1. A DFAO.

2.2. From morphic to arithmetic characterization, via automatic sequences

It is usual to associate numeration systems with infinite words generated by morphisms. In this subsection, we reobtain that the so-called Fibonacci numeration system can be used to characterize Wythoff's sequence. We get another characterization of the  $(A_n, B_n)$ 's when positions are written in the Fibonacci numeration system.

In his seminal paper [4], A. Cobham shows that an infinite word is the image under a coding of an infinite word generated by iterating a morphism of constant length  $k$  if and only this word is  $k$ -automatic. So let us recall the definition of a  $k$ -automatic sequence (see [1] for details).

**Definition 1.** A *deterministic finite automaton with output* (DFAO) is a 6-tuple  $\mathcal{M} = (Q, q_0, \Sigma, \delta, \Gamma, \tau)$  where  $Q$  is a finite set of states,  $q_0 \in Q$  is the initial state,  $\delta : Q \times \Sigma \rightarrow Q$  is the transition function,  $\tau : Q \rightarrow \Gamma$  is the output function and  $\Sigma$  and  $\Gamma$  are respectively the input and the output alphabets. As usual  $\delta$  can be extended to  $Q \times \Sigma^*$  by  $\delta(q, \varepsilon) = q$  and  $\delta(q, \sigma w) = \delta(\delta(q, \sigma), w)$  for all  $q \in Q$ ,  $\sigma \in \Sigma$ ,  $w \in \Sigma^*$ .

Notice that in the next definition, indices in a sequence are counted from zero (that is different from positions in words like in the Fibonacci word where they are counted from one). This shift of one unit cannot be avoided because we consider below representations of any nonnegative integer, zero included.

**Definition 2.** Let  $k \geq 2$ . A sequence  $(x_n)_{n \geq 0} \in \Gamma^{\mathbb{N}}$  is  $k$ -automatic if there exists a DFAO with  $\{0, \dots, k - 1\}$  as input alphabet and  $\Gamma$  as output alphabet such that for all  $n \geq 0$ ,

$$x_n = \tau(\delta(q_0, \rho_k(n)))$$

where  $\rho_k(n)$  denotes the usual  $k$ -ary representation of  $n$ . We also denote by  $\pi_k$  the reciprocal map which gives the numerical value of a word over  $\{0, \dots, k - 1\}$ .

Roughly speaking, one feeds a DFAO with the  $k$ -ary representation of  $n$  from the initial state. After reading the whole representation, the reached state produces an output which gives the element  $x_n$ .

The following example illustrates the two equivalent methods discussed above for generating infinite words (morphism and DFAO).

**Example 3.** Consider the morphism  $\varphi : a \mapsto ab, b \mapsto ac, c \mapsto ca$  of constant length 2 and the coding  $\mu : a, b \mapsto 0, c \mapsto 1$ . We have

$$\varphi^\omega(a) = abacabcaabaccaababacabcacaababac \dots$$

and

$$(x_n)_{n \geq 0} = \mu(\varphi^\omega(a)) = 00010010000110000001001010000001 \dots$$

Now consider the DFAO depicted in Fig. 1 where the set of states is  $\{a, b, c\}$  and where the output  $o = \tau(q)$  of a state  $q$  is written  $q/o$ . Notice that the transitions of the DFAO are in one-to-one cor-

respondence with the morphism  $\varphi$  (i.e., for all  $x \in \{a, b, c\}$ , if  $\varphi(x) = y_0y_1$  then the transitions going out of  $x$  are  $\delta(x, 0) = y_0$  and  $\delta(x, 1) = y_1$ ). Let us explain how it works on an example. Consider the binary representation of eleven,  $\rho_2(11) = 1011$ . We start reading the word 1011 from the initial state  $a$  marked with an entering arrow without label. The automaton reads the word 1011 letter by letter, from left to right, and the state changes accordingly to the transitions:

$$a \xrightarrow{1} b \xrightarrow{0} a \xrightarrow{1} b \xrightarrow{1} c.$$

Since the output from  $c$  is 1, this means that  $x_{11} = 1$ . One can check that the twelfth symbol occurring in  $\mu(\varphi^\omega(a))$  is 1.

It is not difficult to see that the construction shown in the previous example can be extended to any morphism  $\varphi$  of constant length and coding  $\mu$  (for details, see [1,4]).

**Proposition 7.** Let  $\varphi : \Sigma \rightarrow \Sigma^*$  be a morphism of constant length  $\ell$  such that  $\varphi(a)$  starts with  $a$ ,  $\mu : \Sigma \rightarrow \Gamma$  be a coding and  $\mathcal{M} = (\Sigma, a, \{0, \dots, \ell - 1\}, \delta, \Gamma, \mu)$  be the corresponding DFAO. If  $x_n = \sigma \in \Sigma$  and  $\mu(\varphi(\sigma)) = \gamma_0 \cdots \gamma_{\ell-1}$  then

$$x_{\pi_\ell(\rho_\ell(n)i)} = \gamma_i \quad \forall i = 0, \dots, \ell - 1.$$

**Proof.** This is a trivial consequence of the correspondence between the morphism and the DFAO. When writing  $\rho_\ell(n)i$ , one should understand the concatenation of the word  $\rho_\ell(n) \in \{0, \dots, \ell - 1\}^*$  and the digit  $i$ .  $\square$

**Example 4.** We continue Example 3. The fourth element in  $\varphi^\omega(a)$  is  $c$ . The binary representation of 3 (recall that for automatic sequences, we count from zero) is 11. We have  $\pi_2(110) = 6$ ,  $\pi_2(111) = 7$  and  $\mu(\varphi(c)) = \mu(ca) = 10$ . One can check that  $x_6x_7 = 10$  are the seventh and eighth letters in  $\mu(\varphi^\omega(a)) = (x_n)_{n \geq 0}$ .

**Remark 3.** As shown by the previous proposition and example, we stress the fact that when dealing with automatic sequences, we have to deal with indices starting from zero. This relies on the definition of the DFAO related to the morphism and it provides (e.g., Proposition 7) an easy way to deal with the image of a letter appearing in the infinite word.

Cobham's construction can be extended to arbitrary morphisms. Precisely, in [3], positional numeration systems related to a class of linear recurrent sequences are considered (they are related in some sense to Pisot numbers and the corresponding terminology used in [3] is *U-substitution* and *U-automaton* instead of morphism and DFAO). For the general case, see [20] where the construction is linked with abstract numeration systems [17].

**Definition 3 (Fibonacci or Zeckendorf's representation).** The Fibonacci sequence  $(F_n)_{n \geq 0}$  is defined by  $F_0 = 1$ ,  $F_1 = 2$  and  $F_{n+2} = F_{n+1} + F_n$  for all  $n \geq 0$ . Any natural number  $n$  can be written (uniquely) in a greedy way as  $n = \sum_{i=0}^{\ell} c_i F_i$  such that  $\sum_{i=0}^k c_i F_i < F_{k+1}$  for all  $k \leq \ell$  and  $c_\ell = 1$ . It is well known that the  $c_i$ 's are in  $\{0, 1\}$  and such that  $c_\ell \cdots c_0$  does not contain two consecutive 1's (see [18, Chapter 7] or [23]). We write  $\rho_F(n) = c_\ell \cdots c_0$  and this word is said to be the *F-representation* of  $n$ . The *F-representation* of zero is set to  $\varepsilon$ . For any finite alphabet  $A \subset \mathbb{Z}$ , one can define the *F-value* map  $\pi_F : A \rightarrow \mathbb{Z}$  as  $\pi_F(c_\ell \cdots c_0) = \sum_{i=0}^{\ell} c_i F_i$ .

The Fibonacci numeration system belongs to the class studied in [3]. One can therefore associate, with the same construction as the one sketched in Example 3, to the morphism  $\varphi$  defining the Fibonacci word a DFAO  $\mathcal{M}_F$  depicted in Fig. 2 in such a way that the  $n$ th symbol occurring in  $\mathcal{F}$  can be obtain by feeding  $\mathcal{M}_F$  with the *F-representation* of  $n - 1$ . The first symbol in  $\mathcal{F}$  is obtained from the representation of zero (we have exactly the same observation as in Remark 3 which explains this difference of one unit). Notice that since  $\varphi$  is not a constant length morphism, the DFAO  $\mathcal{M}_F$  is not



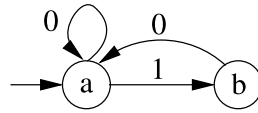

Fig. 2. The DFAO  $\mathcal{M}_F$ .

Table 2

First elements in  $\mathcal{F}$ .

$n$	1	2	3	4	5	6	7	8	9	10	11	12	13	14
	$a$	$b$	$a$	$a$	$b$	$a$	$b$	$a$	$a$	$b$	$a$	$a$	$b$	$a$
$A_i$	1		3	4		6		8	9		11	12		14
$B_i$		2			5		7			10			13	
$\rho_F(n-1)$	$\infty$	$\bar{1}$	10	100	101	1000	1001	1010	10000	10001	10010	10100	10101	100000

complete, meaning that the number of outgoing edges from the different states is not constant (there is only one outgoing edge from  $b$  because  $|\varphi(b)| = 1$ ).

**Example 5.** Feeding  $\mathcal{M}_F$  with the  $F$ -representations of the first integers:  $\varepsilon, 1, 10, 100, 101$ , we get the corresponding outputs  $a, b, a, a, b$ .

**Remark 4.** As a consequence of the special form of the automaton  $\mathcal{M}_F$ , the  $n$ th symbol in  $\mathcal{F}$ ,  $n \geq 2$ , is  $a$  (resp.  $b$ ) if and only if  $\rho_F(n-1)$  ends with 0 (resp. 1). See Table 2 for the first values.

Proposition 7 adapted to the Fibonacci morphism can be expressed as follows.

**Proposition 8.** Let  $\varphi : \{a, b\} \rightarrow \{a, b\}^*$  be the Fibonacci morphism.

- If the  $n$ th letter in  $\mathcal{F}$  is  $a$  ( $n \geq 1$ ), then this  $a$  produces through  $\varphi$  a factor  $ab$  occupying positions  $\pi_F(\rho_F(n-1)0) + 1$  and  $\pi_F(\rho_F(n-1)1) + 1$ .
- If the  $n$ th letter in  $\mathcal{F}$  is  $b$  ( $n \geq 1$ ), then this  $b$  produces through  $\varphi$  a letter  $a$  occupying position  $\pi_F(\rho_F(n-1)0) + 1$ .

**Example 6.** Take the third  $a$  occurring in  $\mathcal{F}$  and having position 4 in  $\mathcal{F}$ . We have  $\rho_F(4-1) = 100$ . By adding 0 and 1 to 100 we get  $\pi_F(1000) = 5$  and  $\pi_F(1001) = 6$ . So the third  $a$  produces the factor  $ab$  in positions 6 and 7 in  $\mathcal{F}$ .

Since the  $n$ th letter  $b$  occurring in  $\mathcal{F}$  is produced through  $\varphi$  by the  $n$ th letter  $a$ , we get the next formula

$$B_n = \pi_F(\rho_F(A_n - 1)1) + 1. \tag{4}$$

**Lemma 3.** For all  $n \geq 1$ ,  $A_n - 1 = \pi_F(\rho_F(n-1)0)$ .

**Proof.** This is simply a reformulation of Remark 4.  $\square$

The previous two results lead to the following arithmetic characterization of Wythoff's sequence.

**Proposition 9** (Arithmetic characterization of Wythoff's sequence). For all  $n \geq 1$ , we have

$$A_n = \pi_F(\rho_F(n-1)0) + 1,$$

$$B_n = \pi_F(\rho_F(A_n - 1)1) + 1.$$

**Remark 5.** An equivalent result was proved in [13] using continued fractions. It was proved that a pair of integers  $(x, y)$  belongs to the sequence  $(A_n, B_n)_{n \geq 1}$  if and only if  $\rho_F(x)$  ends in an even number of zeros and  $\rho_F(y) = \rho_F(x)0$ . As for the algebraic characterization, it was also proved in [13] that such arithmetic characterizations allow to decide in polynomial time whether or not a given position is a  $\mathcal{P}$  position.

The following lemma will be used in Section 4 but is given here because it involves the Fibonacci representation of Wythoff's sequence.

**Lemma 4.** Let  $n \geq 1$  be such that  $B_{n+1} - B_n = 2$ . Then  $\rho_F(B_n - 1)$  ends with 101.

**Proof.** By Lemma 3, we know that  $\rho_F(A_n - 1) = u0$  where  $u = \rho_F(n - 1)$ . Now assume that  $u$  can be written as  $u'0$ . Since  $B_{n+1} - B_n = 2$  and the letter  $b$  occurring in position  $B_n$  (resp.  $B_{n+1}$ ) is produced through  $\varphi$  by the  $n$ th (resp.  $(n + 1)$ th) letter  $a$ , we have  $A_{n+1} - A_n = 1$ . As  $\rho_F(A_n - 1) = u'00$ , we have that  $\rho_F(A_n) = u'01 = \rho_F(A_{n+1} - 1)$  contradicting Lemma 3. Hence  $\rho_F(A_n - 1) = u'10$ , and by Proposition 8, we get  $\rho_F(B_n - 1) = u'101$ .  $\square$

### 2.3. A new characterization of Wythoff's sequence

Consider the infinite Wythoff's matrix over  $\mathbb{N} \times \mathbb{N}$  coding the  $\mathcal{P}$  positions  $(A_n, B_n)$  and  $(B_n, A_n)$  of the Wythoff's game, i.e., for all  $i, j \geq 0$ ,  $P_{i,j} = 1$  if and only if there exists  $n \geq 1$  such that  $(i, j) = (A_n, B_n)$  or  $(i, j) = (B_n, A_n)$ :

$$(P_{i,j})_{i,j \geq 0} = \begin{array}{c|cccccccccccc} i \setminus j & 0 & 1 & 2 & 3 & 4 & 5 & 6 & 7 & 8 & 9 & 10 & \dots \\ \hline 0 & 0 & 0 & 0 & 0 & 0 & 0 & 0 & 0 & 0 & 0 & 0 & \dots \\ 1 & 0 & 0 & \mathbf{1} & 0 & 0 & 0 & 0 & 0 & 0 & 0 & 0 & \\ 2 & 0 & \mathbf{1} & 0 & 0 & 0 & 0 & 0 & 0 & 0 & 0 & 0 & \\ 3 & 0 & 0 & 0 & 0 & 0 & \mathbf{1} & 0 & 0 & 0 & 0 & 0 & \\ 4 & 0 & 0 & 0 & 0 & 0 & 0 & 0 & \mathbf{1} & 0 & 0 & 0 & \\ 5 & 0 & 0 & 0 & \mathbf{1} & 0 & 0 & 0 & 0 & 0 & 0 & 0 & \\ 6 & 0 & 0 & 0 & 0 & 0 & 0 & 0 & 0 & 0 & 0 & \mathbf{1} & \\ 7 & 0 & 0 & 0 & 0 & \mathbf{1} & 0 & 0 & 0 & 0 & 0 & 0 & \\ 8 & 0 & 0 & 0 & 0 & 0 & 0 & 0 & 0 & 0 & 0 & 0 & \\ 9 & 0 & 0 & 0 & 0 & 0 & 0 & 0 & 0 & 0 & 0 & 0 & \\ 10 & 0 & 0 & 0 & 0 & 0 & 0 & \mathbf{1} & 0 & 0 & 0 & 0 & \\ \vdots & \vdots & & & & & & & & & & & \ddots \end{array}$$

The aim of this section is to provide a two-dimensional iterated construction that builds Wythoff's matrix  $(P_{i,j})$ . Let us stress the fact that even if we have already provided several characterizations of the  $\mathcal{P}$  positions, it is not obvious that such characterizations lead to some two-dimensional morphism. Indeed this morphism requires some extra property, namely a shape symmetric property, to generate an infinite picture in a convenient way.

Automatic sequences have been generalized to the multi-dimensional case [21]. Here we will consider solely the two-dimensional situation. An array over  $\mathbb{N} \times \mathbb{N}$  is said to be  $k$ -automatic if there exists a morphism  $\varphi : \Sigma \rightarrow \Sigma^{k \times k}$  whose images are  $k \times k$  blocks of symbols in  $\Sigma$  and which can be iterated in the same spirit as for the one-dimensional case (there is a symbol  $a$  whose image under  $\varphi$  has  $a$  in the upper-left corner just as  $\varphi(a) = au$  in the one-dimensional case). After having obtained the array  $\varphi^\omega(a)$ , a coding  $\mu : \Sigma \rightarrow \Gamma$  can still be applied. Equivalently, such arrays can be produced by a DFAO reading pairs of words of the same length (leading zeroes are added to the shortest of the two  $k$ -ary representations).

In the one-dimensional case, morphisms of constant length can easily be generalized to non-constant length morphisms. For two-dimensional arrays, one has to proceed carefully to obtain a

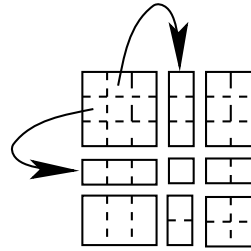

Fig. 3. Iteration of a shape-symmetric morphism.

meaningful “picture” when iterating a morphism whose images are not all  $k \times k$  blocks (with images of arbitrary rectangular shape, positions of the newly produced blocks cannot be uniquely determined or images of different letters could also overlap). This is the reason for introducing the notion of *shape-symmetric morphisms* [19]. Roughly speaking, each iteration of  $\varphi$  gives a square built from images of letters and these images have shape which are symmetric with respect to the main diagonal of the square. The particular shape of the images implies that we do not have problems to iterate the process. Precisely, if  $P$  is the infinite two-dimensional picture that is the fixed point of  $\varphi$ , then for all  $i, j \in \mathbb{N}$ , if  $\varphi(P_{i,j})$  is a block of size  $k \times \ell$  then  $\varphi(P_{j,i})$  is of size  $\ell \times k$ . See Fig. 3 for an example.

**Example 7.** Let  $\varphi$  be the following two-dimensional shape-symmetric morphism:

$$\begin{aligned} \varphi : a \mapsto \begin{array}{|c|c|} \hline a & b \\ \hline c & d \\ \hline \end{array} & \quad b \mapsto \begin{array}{|c|} \hline i \\ \hline e \\ \hline \end{array} & \quad c \mapsto \begin{array}{|c|c|} \hline i & j \\ \hline \end{array} & \quad d \mapsto \begin{array}{|c|} \hline i \\ \hline \end{array} & \quad e \mapsto \begin{array}{|c|c|} \hline f & b \\ \hline \end{array} \\ \\ f \mapsto \begin{array}{|c|c|} \hline g & b \\ \hline h & d \\ \hline \end{array} & \quad g \mapsto \begin{array}{|c|c|} \hline f & b \\ \hline h & d \\ \hline \end{array} & \quad h \mapsto \begin{array}{|c|c|} \hline i & m \\ \hline \end{array} & \quad i \mapsto \begin{array}{|c|c|} \hline i & m \\ \hline h & d \\ \hline \end{array} \\ \\ j \mapsto \begin{array}{|c|} \hline k \\ \hline c \\ \hline \end{array} & \quad k \mapsto \begin{array}{|c|c|} \hline l & m \\ \hline c & d \\ \hline \end{array} & \quad l \mapsto \begin{array}{|c|c|} \hline k & m \\ \hline c & d \\ \hline \end{array} & \quad m \mapsto \begin{array}{|c|} \hline i \\ \hline h \\ \hline \end{array} \end{aligned}$$

and the coding

$$\mu : e, g, j, l \mapsto 1, \quad a, b, c, d, f, h, i, k, m \mapsto 0.$$

Successive applications of  $\varphi$  from  $a$  lead to an infinite array. When applying the coding  $\mu$  to this array, we will show that we obtain again the infinite matrix coding the  $P$ -positions of Wythoff's game (symbols mapped onto 1 have been written in bold face).

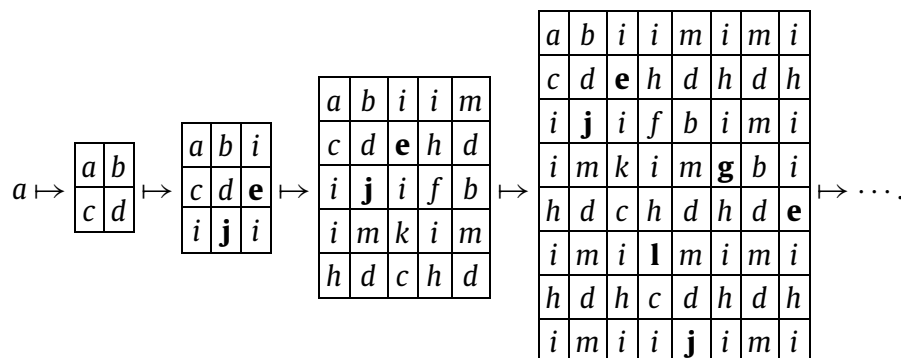

Fig. 7 in Appendix A gives a colored version (with respect to the different symbols) of the first  $50 \times 50$  block associated with  $\varphi^\omega(a)$ .

**Remark 6.** Consider the first row (or similarly due to the symmetry, the first column) of the morphism  $\varphi$  which gives

$$\alpha : a \mapsto ab, \quad b \mapsto i, \quad i \mapsto im, \quad m \mapsto i$$

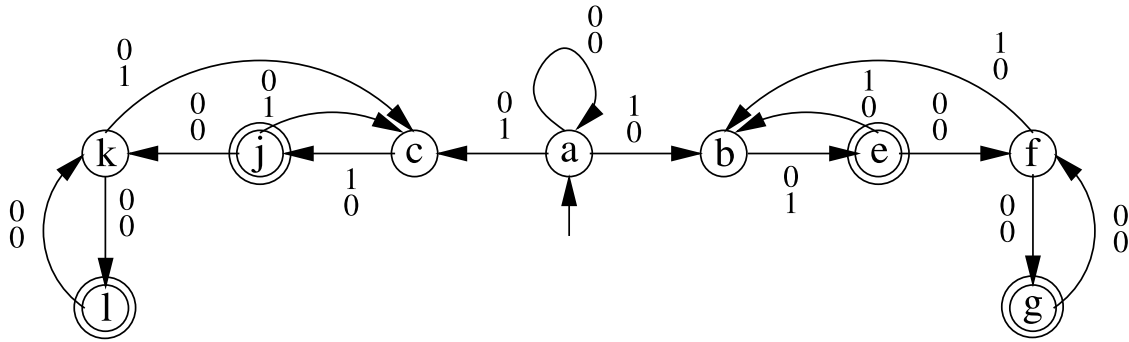

Fig. 4. Automaton accepting  $F$ -representations of  $(A_n, B_n)$  and  $(B_n, A_n)$ .

and with the coding

$$\beta : a, i \mapsto a, \quad b, m \mapsto b$$

we find that  $\beta(\alpha^\omega(a))$  is the Fibonacci word. Due to the shape of the morphism  $\varphi$  or in the same way  $\alpha$ , it is obvious that  $F$ -representations will be considered.

The one-dimensional case considered in Example 3 can be extended to a two-dimensional morphism  $\varphi$  like the one given in Example 7. We associate in a canonical way a DFAO whose input alphabet is

$$\left\{ \begin{pmatrix} 0 \\ 0 \end{pmatrix}, \begin{pmatrix} 1 \\ 0 \end{pmatrix}, \begin{pmatrix} 0 \\ 1 \end{pmatrix}, \begin{pmatrix} 1 \\ 1 \end{pmatrix} \right\}.$$

The set of states is  $\{a, b, \dots, l, m\}$ , the initial state is  $a$ . If

$$\varphi(r) = \begin{array}{|c|c|} \hline s & t \\ \hline u & v \\ \hline \end{array}, \quad \begin{array}{|c|c|} \hline s & t \\ \hline \end{array}, \quad \begin{array}{|c|} \hline s \\ \hline u \\ \hline \end{array} \quad \text{or} \quad \begin{array}{|c|} \hline s \\ \hline \end{array}$$

then we have transitions like

$$r \xrightarrow{\begin{pmatrix} 0 \\ 0 \end{pmatrix}} s, \quad r \xrightarrow{\begin{pmatrix} 1 \\ 0 \end{pmatrix}} t, \quad r \xrightarrow{\begin{pmatrix} 0 \\ 1 \end{pmatrix}} u, \quad r \xrightarrow{\begin{pmatrix} 1 \\ 1 \end{pmatrix}} v.$$

As a consequence of the above construction and Remark 6, we get the following result which is simply the extension of the phenomenon observed in the one-dimensional case.

**Proposition 10.** Feeding the automaton  $\mathcal{M}$  associated with a two-dimensional shape-symmetric morphism  $\varphi$  from state  $a$  with the word

$$\begin{pmatrix} \rho_F(m) \\ \rho_F(n) \end{pmatrix} \in \left\{ \begin{pmatrix} 0 \\ 0 \end{pmatrix}, \begin{pmatrix} 1 \\ 0 \end{pmatrix}, \begin{pmatrix} 0 \\ 1 \end{pmatrix}, \begin{pmatrix} 1 \\ 1 \end{pmatrix} \right\}^*$$

leads to the state  $[\varphi^\omega(a)]_{m,n}$ .

In the previous statement, it is understood that the shortest  $F$ -representation is padded with leading zeroes.

**Example 8.** We continue Example 7. The automaton associated with  $\varphi$  is depicted in Fig. 4.

To simplify the presentation, we have not represented states  $d, h, i, m$  and the corresponding transitions. (There is no edge from  $d, h, i, m$  to some other states.) States  $g, e, j, l$  have been represented with double circles indicating that they correspond to output 1 (the other states have all output 0).

Considering the pair  $(A_4, B_4) = (6, 10)$  represented as

$$\begin{pmatrix} 01001 \\ 10010 \end{pmatrix}$$

we get the sequence

$$a \xrightarrow{\binom{0}{1}} c \xrightarrow{\binom{1}{0}} j \xrightarrow{\binom{0}{1}} k \xrightarrow{\binom{0}{1}} c \xrightarrow{\binom{1}{0}} j.$$

One can easily check that the automaton in Fig. 4 accepts exactly words of the form

$$\begin{pmatrix} 0w_1 \cdots w_\ell \\ w_1 \cdots w_\ell 0 \end{pmatrix} \quad \text{and} \quad \begin{pmatrix} w_1 \cdots w_\ell 0 \\ 0w_1 \cdots w_\ell \end{pmatrix}$$

where  $w_1 \cdots w_\ell$  is a valid  $F$ -representation ending with an even number of zeroes. As said in Remark 5, it is well known that such pairs of words represent exactly the  $(A_n, B_n)$ 's and  $(B_n, A_n)$ 's. Therefore we obtain the following characterization about Wythoff's matrix.

**Proposition 11** (Two-dimensional morphic characterization of Wythoff's matrix). *The morphism  $\varphi$  and the coding  $\mu$  defined in Example 7 generate exactly the Wythoff's matrix, i.e.,  $\mu(\varphi^\omega(a)) = (P_{i,j})$ .*

### 3. Extensions of Wythoff's game preserving Wythoff's sequence as a set of $\mathcal{P}$ positions

We first consider extensions of Wythoff's game where a single move  $(i, j)$  is adjoined to the original Wythoff's rules, and we require that these extensions all have Wythoff's sequence as a set of  $\mathcal{P}$  positions. Otherwise stated, the set of  $\mathcal{P}$  positions is invariant. Note that when a move  $(i, j)$  is adjoined, this means that from all game positions, one can possibly remove  $i$  and  $j$  tokens from the two heaps whenever enough token are available from this position. Adding more than a single move can then be handled easily.

Let  $W$  be the infinite matrix over  $\mathbb{N} \times \mathbb{N}$  coding the moves  $(i, j)$  that can be adjoined with respect to the required property, i.e., for all  $i, j \geq 0$  we have  $W_{i,j} \neq 1$  if and only if Wythoff's game with the adjoined move  $(i, j)$  has Wythoff's sequence as its set of  $\mathcal{P}$  positions.

#### 3.1. Polynomial extensions

As detailed in Proposition 5, we have two algebraic conditions to decide whether  $W_{i,j} = 1$ . However, as explained in the introduction and by reference to [10], since we investigate tractable extensions of Wythoff's game, we also need to test these conditions in polynomial time.

The following proposition gives an equivalent formulation to condition (1) of Proposition 5. In particular, it shows that deciding whether a move  $(i, j)$  satisfies condition (1) can be done in polynomial time. However, it turns out that testing condition (2) in polynomial time is not so immediate.

**Proposition 12.** *We have*

$$\{(A_j - A_i, B_j - B_i) \mid j > i \geq 0\} = \{(A_n, B_n) \mid n > 0\} \cup \{(A_n + 1, B_n + 1) \mid n > 0\}.$$

Moreover, for any  $j > i \geq 0$  we have  $(A_j - A_i, B_j - B_i) = (A_{j-i}, B_{j-i})$  or  $(A_{j-i} + 1, B_{j-i} + 1)$ .

**Proof.** Consider a pair  $(A_j - A_i, B_j - B_i)$  for some  $j > i \geq 0$ . From Proposition 4, we have  $(A_j - A_i, B_j - B_i) = (\lfloor j\tau \rfloor - \lfloor i\tau \rfloor, \lfloor j\tau \rfloor - \lfloor i\tau \rfloor + j - i)$ . Notice that

$$\lfloor j\tau \rfloor - \lfloor i\tau \rfloor = (j - i)\tau - \{j\tau\} + \{i\tau\} = \lfloor (j - i)\tau \rfloor + \{(j - i)\tau\} - \{j\tau\} + \{i\tau\}$$

and

$$\{(j - i)\tau\} = \begin{cases} \{j\tau\} - \{i\tau\} & \text{if } \{j\tau\} > \{i\tau\}, \\ 1 + \{j\tau\} - \{i\tau\} & \text{if } \{j\tau\} < \{i\tau\}. \end{cases}$$

Consequently, by setting  $n = j - i > 0$ , we get

$$A_j - A_i = \lfloor j\tau \rfloor - \lfloor i\tau \rfloor = \begin{cases} A_n & \text{if } \{j\tau\} > \{i\tau\}, \\ A_n + 1 & \text{if } \{j\tau\} < \{i\tau\}. \end{cases}$$

Moreover,

$$B_j - B_i = \lfloor j\tau \rfloor - \lfloor i\tau \rfloor + j - i = \begin{cases} A_n + n = B_n & \text{if } \{j\tau\} > \{i\tau\}, \\ A_n + n + 1 = B_n + 1 & \text{if } \{j\tau\} < \{i\tau\}. \end{cases}$$

Now take a pair  $(s, t)$  in  $\{(A_n, B_n) \mid n > 0\} \cup \{(A_n + 1, B_n + 1) \mid n > 0\}$ . If  $(s, t) = (A_n, B_n)$  for some  $n > 0$  then choose  $j = n$  and  $i = 0$  to get  $(s, t) = (A_j - A_i, B_j - B_i)$ . Otherwise,  $(s, t) = (A_n + 1, B_n + 1)$  for some  $n > 0$ . Notice that for all  $k \geq 0$

$$\{(k + n)\tau\} = \{\{k\tau\} + \{n\tau\}\}.$$

Since  $\{\{k\tau\} \mid k \geq 0\}$  is dense in  $[0, 1]$ , there exists  $i \geq 0$  such that

$$1 - \{n\tau\} < \{i\tau\} < 1.$$

In particular, we have  $\{(i + n)\tau\} < \{n\tau\}$ . We set  $j = i + n$  and with the same arguments as in the first part of this proof, we have that

$$(A_n + 1, B_n + 1) = (A_j - A_i, B_j - B_i). \quad \square$$

In order to find a polynomial characterization of the condition (2) of Proposition 5, we will prove the following result. Its proof requires first several technical lemmas and will be given at the end of this section.

**Proposition 13.** *Given a pair  $(i, j)$  of positive integers,  $(i, j) \in \{(A_n - B_m, B_n - A_m) \mid n > m \geq 0\}$  if and only if  $\rho_F(j - A_i - 2) = u1$  and  $\rho_F(j - A_i - 2 + i) = u'0$ , for any two valid  $F$ -representations  $u$  and  $u'$  in  $\{0, 1\}^*$ .*

Putting together Propositions 12 and 13, we get a polynomial characterization of the matrix  $W$ .

**Corollary 1.** *For any pair  $(i, j)$  of positive integers, we have  $W_{i,j} = 1$  if and only if one of the three following properties is satisfied:*

- $(\rho_F(i - 1), \rho_F(j - 1)) = (u0, u01)$  for any valid  $F$ -representation  $u$  in  $\{0, 1\}^*$ .
- $(\rho_F(i - 2), \rho_F(j - 2)) = (u0, u01)$  for any valid  $F$ -representation  $u$  in  $\{0, 1\}^*$ .
- $(\rho_F(j - A_i - 2), \rho_F(j - A_i - 2 + i)) = (u1, u'0)$  for any two valid  $F$ -representations  $u$  and  $u'$  in  $\{0, 1\}^*$ .

**Proof.** The first two properties come from Propositions 12 and 9. The last property is exactly Proposition 13. As explained in [13], the computation of the  $F$ -representation of an integer can be done in polynomial time.  $\square$

The above corollary leads to a complete characterization of the extensions of Wythoff's game that preserve Wythoff's sequence as a set of  $\mathcal{P}$  positions.

**Corollary 2.** *Let  $I \subseteq \mathbb{Z}_{\geq 1}$ . Then Wythoff's game with the set of adjoined moves  $\{(x_i, y_i) : i \in I, x_i, y_i \in \mathbb{Z}_{\geq 0}\}$  has the sequence  $(A_n, B_n)$  as a set of  $\mathcal{P}$  positions if and only if  $W_{x_i, y_i} \neq 1$  for all  $i \in I$ .*

**Proof.** Trivially, any game with an adjoined move  $(x_i, y_i)$  such that  $W_{x_i, y_i} = 1$  cannot have  $(A_n, B_n)$  as a set of  $\mathcal{P}$  positions. Moreover, the sequence  $(A_n, B_n)$  still satisfies the two properties of Proposition 1, even when adding a set of moves  $\{(x_i, y_i) : i \in I, x_i, y_i \in \mathbb{Z}_{\geq 0}\}$  with  $W_{x_i, y_i} \neq 1$  for all  $i \in I$ .  $\square$

We now turn to a succession of three results leading to the proof of Proposition 13.

**Table 3**  
Illustration of Lemma 5.

$n$	$\rho_F(n)$	$\mathcal{F}_n$	$\rho_F(n)0$	$\pi_F(\rho_F(n)0)$	$am = p; \varphi(\mathcal{F}_n)$
1	1	$a$	10	2	$ab$
2	10	$ab$	100	3	$aba$
3	100	$aba$	1000	5	$abaab$
4	101	$abaa$	1010	7	$abaabab$
5	1000	$abaab$	10000	8	$abaababa$
6	1001	$abaaba$	10010	10	$abaababaab$

**Lemma 5.** Let  $\mathcal{F}_n$  be the prefix of length  $n$  of the Fibonacci word  $\mathcal{F}$ . We have

$$|\varphi(\mathcal{F}_n)| = \pi_F(\rho_F(n)0).$$

**Proof.** (See Table 3 for  $1 \leq n \leq 6$ .) Consider the sequence of words  $(f_k)_{k \geq 0}$  defined by  $f_0 = a$ ,  $f_1 = ab$  and  $f_{k+2} = f_{k+1}f_k$ . Observe that  $|f_k| = F_k$  for all  $k \geq 0$  because  $|f_{k+2}| = |f_{k+1}| + |f_k|$ . Moreover, it is well known (see for instance [18]) that  $f_k = \varphi^k(a)$ . Let  $n$  be such that  $\rho_F(n) = c_\ell \cdots c_0$  and consider the prefix  $t$  of  $\mathcal{F}$  of length  $n > 0$ . Let  $i_1 < \cdots < i_r \in \{0, \dots, \ell\}$  be the indices such that  $c_{i_j} = 1$  in the  $F$ -representation of  $n$ , i.e.,  $n = \sum_{j=1}^r F_{i_j}$ . The word  $t$  can be factorized as

$$t = u_r \cdots u_1 \quad \text{with } |u_j| = F_{i_j}, \quad j = 1, \dots, r.$$

As an example, considering the prefix of  $\mathcal{F}$  of length  $20 = F_5 + F_3 + F_1$ , we have the factorization

$$\underbrace{abaababaabaab}_{u_5} \underbrace{abaab}_{u_3} \underbrace{ab}_{u_1} \cdots$$

To conclude the proof, we now observe that  $u_j = f_{i_j}$  for all  $j \in \{1, \dots, r\}$ . Indeed,  $\mathcal{F}$  has  $f_{i_r}f_{i_r-1}$  as prefix and  $f_{i_r-1}$  can be written as  $f_{i_r-2}f_{i_r-3}$ . Continuing this way, we obtain the expected factorization

$$t = f_{i_r} \cdots f_{i_1} \quad \text{and} \quad \varphi(t) = \varphi(f_{i_r}) \cdots \varphi(f_{i_1}).$$

Since  $\varphi(f_k) = \varphi(\varphi^k(a)) = \varphi^{k+1}(a) = f_{k+1}$ , we get

$$|\varphi(t)| = \sum_{j=1}^r F_{i_j+1} = \sum_{i=0}^{\ell} c_i F_{i+1} = \pi_F(c_\ell \cdots c_0 0). \quad \square$$

The next lemma is technical and is primarily devoted to prove Theorem 1. We will only use the first part of the statement, but we get the other for free using the same reasoning.

**Lemma 6.** Let  $u1 \in \{0, 1\}^*$  be a valid  $F$ -representation. If  $\rho_F(\pi_F(u1) + n)1$  is also a valid  $F$ -representation, then

$$\pi_F(\rho_F(\pi_F(u1) + n)1) = \pi_F(u00) + \pi_F(\rho_F(n - 1)0) + 4.$$

Otherwise,  $\rho_F(\pi_F(u1) + n)1$  is not a valid  $F$ -representation and

$$\pi_F(\rho_F(\pi_F(u1) + n)0) = \pi_F(u00) + \pi_F(\rho_F(n)0) + 2.$$

**Proof.** Since  $u1$  is an  $F$ -representation,  $u$  ends with 0. Therefore,  $p_0 = \pi_F(u) + 1$  is the position of a letter  $a$  in  $\mathcal{F}$ . This  $a$  produces  $ab$  and the position of the corresponding  $b$  is  $p_1 = \pi_F(u1) + 1$ . The letter in position  $p_2 = \pi_F(u1) + 2$  is  $a$  (no two consecutive  $b$ 's in  $\mathcal{F}$ ). Let us consider the first case and assume that  $\rho_F(\pi_F(u1) + n)1$  is a valid  $F$ -representation. This means that  $\rho_F(\pi_F(u1) + n)$  ends with 0 and thus there is also a letter  $a$  in position  $p_3 = \pi_F(u1) + n + 1$ . This latter  $a$  produces a factor

$ab$  where  $b$  has position  $p_4 = \pi_F(\rho_F(\pi_F(u1) + n)1) + 1$ . The following scheme gives a factorization of the prefix of  $\mathcal{F}$  of length  $p_4$ :

$$\mathcal{F} = \underbrace{\text{---} \overset{p_0}{a} \text{---}}_x \underbrace{\text{---} \overset{p_1}{a} \overset{p_2}{b} \text{---}}_y \underbrace{\text{---} \overset{p_3}{a} \text{---} \overset{p_4}{a} \overset{p_4}{b} \text{---}}_z \text{---}.$$

Notice that  $\varphi(xya) = xyz$ . Therefore,  $|\varphi(xya)| = p_4$  and

$$|\varphi(xy)| = p_4 - 2 = \pi_F(\rho_F(\pi_F(u1) + n)1) - 1.$$

On the other hand, since  $|\varphi(x)| = \pi_F(u10) + 1$  (because the  $b$  in position  $p_1$  produces the  $a$  in position  $\pi_F(u10) + 1$ ), we get

$$|\varphi(xy)| = |\varphi(x)| + |\varphi(y)| = \pi_F(u00) + 3 + |\varphi(y)|.$$

Now observe that the factor  $bya$  starting in position  $p_1$ , with  $|y| = p_3 - p_1 - 1 = n - 1$ , satisfies exactly the hypothesis of Lemma 2. Therefore  $y$  is a permutation of the prefix  $t$  of  $\mathcal{F}$  of length  $n - 1$ . Obviously,  $|\varphi(y)| = |\varphi(t)|$  because  $|y|_a = |t|_a$  and  $|y|_b = |t|_b$ . From Lemma 5,  $|\varphi(t)| = \pi_F(\rho_F(n - 1)0)$  and the conclusion follows.

Consider the second case, assume now that there is a letter  $b$  in position  $p_3 = \pi_F(u1) + n + 1$  (i.e.,  $\rho_F(\pi_F(u1) + n)$  ends with 1 and cannot be followed by another 1 to obtain a valid  $F$ -representation). This  $b$  produces a letter  $a$  in position  $p'_4 = \pi_F(\rho_F(\pi_F(u1) + n)0) + 1$ . The following scheme gives a factorization of the prefix of  $\mathcal{F}$  of length  $p'_4$ :

$$\mathcal{F} = \underbrace{\text{---} \overset{p_0}{a} \text{---}}_x \underbrace{\text{---} \overset{p_1}{a} \overset{p_2}{b} \text{---}}_y \underbrace{\text{---} \overset{p_3}{b} \text{---} \overset{p'_4}{a} \text{---}}_z \text{---}.$$

Notice that  $\varphi(xyb) = xyz$  and  $|\varphi(xyb)| = p'_4 = \pi_F(\rho_F(\pi_F(u1) + n)0) + 1$ . On the other hand,  $|\varphi(xyb)| = |\varphi(x)| + |\varphi(yb)| = \pi_F(u00) + 3 + |\varphi(yb)|$ . The factor  $byba$  starting in position  $p_1$  ( $b$  is always followed by  $a$  in  $\mathcal{F}$ ), with  $|yb| = p_3 - p_1 = n$ , satisfies the hypothesis of Lemma 2. Therefore  $yb$  is a permutation of the prefix  $t$  of  $\mathcal{F}$  of length  $n$  and  $|\varphi(t)| = |\varphi(yb)| = \pi_F(\rho_F(n)0)$  and the conclusion follows.  $\square$

**Theorem 1.** Let  $i, j$  be such that  $A_j - B_i = n > 0$ . We have

$$B_j - A_i = B_i + A_n + 1.$$

**Proof.** Let  $u \in \{0, 1\}^*$  be the  $F$ -representation of  $A_i - 1$ . Thanks to (4),  $u1$  is the  $F$ -representation of  $B_i - 1$  (in particular,  $\pi_F(u1) = B_i - 1$ ). By hypothesis,  $A_j - 1 = B_i - 1 + n$ . Therefore,  $\pi_F(u1) + n = A_j - 1$ . Since the  $j$ th  $a$  produces the  $j$ th  $b$  in  $\mathcal{F}$ , we get again using (4) that

$$B_j - 1 = \pi_F(\rho_F(\pi_F(u1) + n)1).$$

Putting together the informations we have collected so far, we have

$$\begin{aligned} B_j - A_i &= (B_j - 1) - (A_i - 1) \\ &= \pi_F(\rho_F(\pi_F(u1) + n)1) - \pi_F(u) \\ &= \pi_F(u00) + A_n + 3 - \pi_F(u) \end{aligned}$$

where we used Lemmas 3 and 6 on the last line (notice that  $\rho_F(\pi_F(u1) + n)1$  is a valid  $F$ -representation). Write  $u$  as  $u_\ell \dots u_0$ . Notice that

$$\pi_F(u00) - \pi_F(u) = \sum_{i=0}^{\ell} u_i F_{i+2} - \sum_{i=0}^{\ell} u_i F_i = \sum_{i=0}^{\ell} u_i \underbrace{(F_{i+2} - F_i)}_{=F_{i+1}} = \pi_F(u0).$$



Consequently, since  $F_0 = 1$ , we get

$$B_j - A_i = \pi_F(u0) + 3 + A_n = \pi_F(u1) + 2 + A_n = B_i + A_n + 1. \quad \square$$

**Proof of Proposition 13.** Let  $(i, j)$  be a pair of positive integers satisfying  $i = A_n - B_m$  and  $j = B_n - A_m$  for some integers  $n > m \geq 0$ . By Theorem 1, we have  $j = B_n - A_m = B_m + A_i + 1$ . Hence  $B_m - 1 = j - A_i - 2$ , and by Proposition 9, this implies that  $\rho_F(j - A_i - 2)$  ends with a 1. Moreover, we also get  $A_n - 1 = B_m + i - 1 = j - A_i - 2 + i$ , and with the same proposition, we conclude that  $\rho_F(j - A_i - 2 + i)$  ends with a 0.

Now consider a pair  $(i, j)$  of nonnegative integers satisfying  $\rho_F(j - A_i - 2) = u1$  and  $\rho_F(j - A_i - 2 + i) = u'0$ , for any two valid  $F$ -representations  $u$  and  $u'$  in  $\{0, 1\}^*$ . Using Propositions 9 and 3, there exist two positive integers  $m$  and  $n$  such that  $j - A_i - 2 = B_m - 1$  and  $j - A_i - 2 + i = A_n - 1$ . The latter equality leads to  $i = A_n + 1 + A_i - j$ , which is equal to  $A_n - B_m$  in view of the previous one. By applying Theorem 1 to the equality  $A_n - B_m = i$ , we also get  $B_k - A_m = B_m + A_i + 1 = j$ . This concludes the proof.  $\square$

### 3.2. Two-dimensional morphic characterization of the matrix $W$

As in Section 2.3 where Wythoff's matrix was investigated, we build a two-dimensional shape symmetric morphism to generate the matrix  $W$

$$(W_{i,j})_{i,j \geq 0} = \begin{array}{cccccccccccc} 0 & 0 & 0 & 0 & 0 & 0 & 0 & 0 & 0 & 0 & 0 & \dots \\ 0 & 0 & 1 & 0 & 1 & 0 & 0 & 1 & 0 & 1 & 0 & \\ 0 & 1 & 0 & 1 & 0 & 0 & 1 & 0 & 0 & 0 & 0 & \\ 0 & 0 & 1 & 0 & 0 & 1 & 0 & 0 & 0 & 0 & 1 & \\ 0 & 1 & 0 & 0 & 0 & 0 & 1 & 1 & 0 & 1 & 0 & \\ 0 & 0 & 0 & 1 & 0 & 0 & 0 & 0 & 1 & 0 & 0 & \\ 0 & 0 & 1 & 0 & 1 & 0 & 0 & 0 & 0 & 0 & 1 & \\ 0 & 1 & 0 & 0 & 1 & 0 & 0 & 0 & 0 & 0 & 0 & \\ 0 & 0 & 0 & 0 & 0 & 1 & 0 & 0 & 0 & 0 & 0 & \\ 0 & 1 & 0 & 0 & 1 & 0 & 0 & 0 & 0 & 0 & 0 & \\ 0 & 0 & 0 & 1 & 0 & 0 & 1 & 0 & 0 & 0 & 0 & \\ \vdots & & & & & & & & & & \ddots & \end{array}$$

Consider the morphism

$$\begin{array}{l} \psi : a \mapsto \begin{bmatrix} a & b \\ c & d \end{bmatrix} \quad b \mapsto \begin{bmatrix} e \\ f \end{bmatrix} \quad c \mapsto \begin{bmatrix} e & h \end{bmatrix} \quad d \mapsto \begin{bmatrix} i \end{bmatrix} \quad e \mapsto \begin{bmatrix} j & k \\ l & m \end{bmatrix} \quad f \mapsto \begin{bmatrix} g & b \end{bmatrix} \\ g \mapsto \begin{bmatrix} y & b \\ o & t \end{bmatrix} \quad h \mapsto \begin{bmatrix} z \\ c \end{bmatrix} \quad i \mapsto \begin{bmatrix} i & n \\ o & d \end{bmatrix} \\ j \mapsto \begin{bmatrix} e & p \\ q & r \end{bmatrix} \quad k \mapsto \begin{bmatrix} e \\ s \end{bmatrix} \quad l \mapsto \begin{bmatrix} e & u \end{bmatrix} \quad m \mapsto \begin{bmatrix} e \end{bmatrix} \\ n \mapsto \begin{bmatrix} i \\ o \end{bmatrix} \quad o \mapsto \begin{bmatrix} i & n \end{bmatrix} \quad p \mapsto \begin{bmatrix} e \\ q \end{bmatrix} \quad q \mapsto \begin{bmatrix} e & p \end{bmatrix} \quad r \mapsto \begin{bmatrix} e \end{bmatrix} \quad s \mapsto \begin{bmatrix} v & k \end{bmatrix} \\ t \mapsto \begin{bmatrix} i \end{bmatrix} \quad u \mapsto \begin{bmatrix} w \\ l \end{bmatrix} \quad v \mapsto \begin{bmatrix} w & p \\ l & r \end{bmatrix} \quad w \mapsto \begin{bmatrix} v & k \\ q & r \end{bmatrix} \\ x \mapsto \begin{bmatrix} z & n \\ c & d \end{bmatrix} \quad y \mapsto \begin{bmatrix} g & b \\ o & d \end{bmatrix} \quad z \mapsto \begin{bmatrix} x & n \\ c & t \end{bmatrix} \end{array}$$

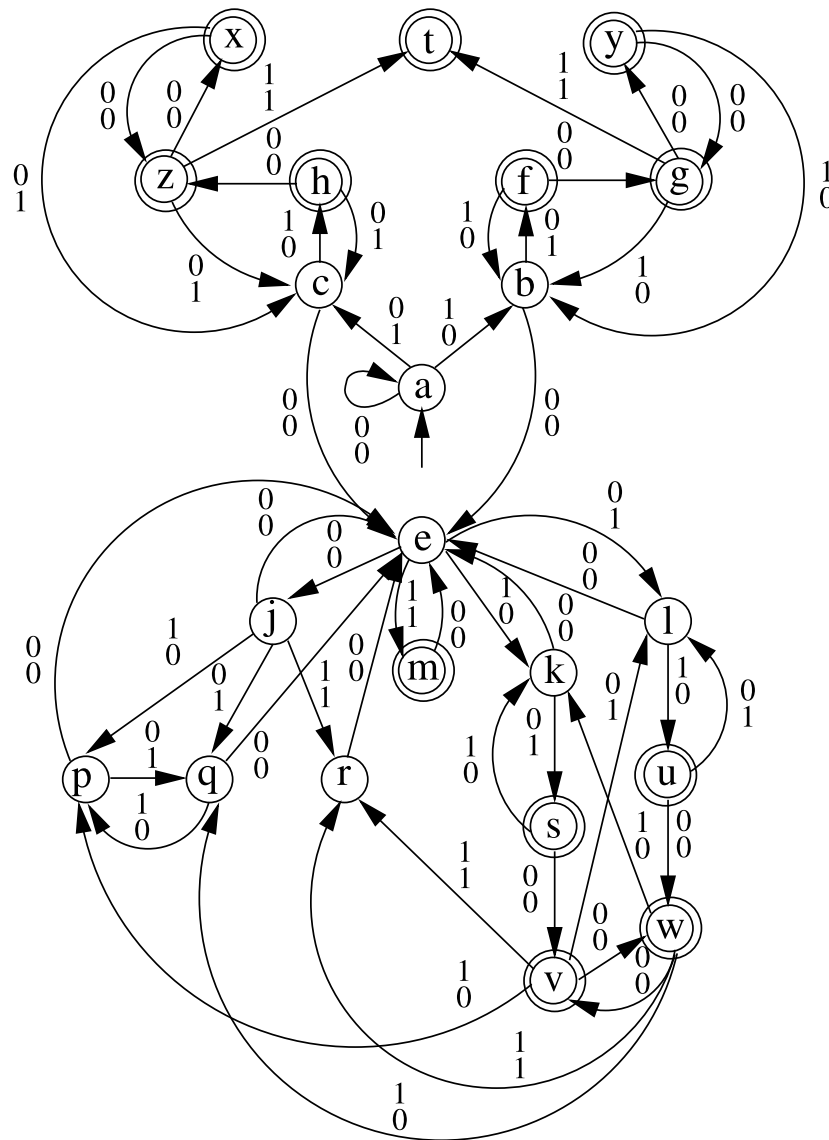

Fig. 5. The DFAO associated with  $\psi$  and  $\nu$ .

and the coding

$$\nu : a, b, c, d, e, i, j, k, l, n, o, p, q, r \mapsto 0, \quad f, g, h, m, s, t, u, v, w, x, y, z \mapsto 1.$$

Fig. 8 in Appendix A gives a colored version (with respect to the different symbols) of the first  $50 \times 50$  block associated with  $\psi^\omega(a)$ .

Using the same procedure as in Section 2.3, we state the following conjecture analogous to Proposition 11. Let us mention that even if Corollary 1 gives some syntactical criteria to test, this does not imply that an automaton exists and even if such an automaton exists (which is the case), this does not in general lead to a generating morphism.

**Conjecture 1.** *The morphisms  $\psi$  and the coding  $\nu$  generate exactly the matrix  $W$ , i.e.,  $\nu(\psi^\omega(a)) = W$ .*

**Partial proof.** All we have to do is to provide the automaton associated with  $\psi$  and  $\nu$  and check that the language accepted by this automaton corresponds with the one given by Corollary 1. This automaton is depicted in Fig. 5 without representing the non-accepting states  $d, i, n$  and  $o$  (there is no edge from these states to any other state).

For the first two cases of Corollary 1, representations of  $i - 1$  and  $j - 1$  (resp.  $i - 2$  and  $j - 2$ ) are considered. We have therefore to consider the addition of one or two to show the expected

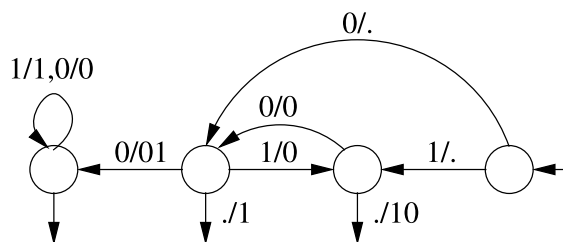

Fig. 6. The successor function for the Fibonacci system.

correspondence. It is well known that the successor function in the Fibonacci numeration system is right sequential and right on-line computable with delay 1 (see [16]) and it is realized by the transducer depicted in Fig. 6. This transducer reads the representation of  $n$  from the right (i.e., least significant digit first) and produces the representation of  $n + 1$  as output. Assume first that  $(i, j)$  is such that  $(\rho_F(i - 1), \rho_F(j - 1)) = (u0, u01)$ . If  $u$  ends with 0, using the transducer in Fig. 6, we get

$$(\rho_F(i), \rho_F(j)) = (u1, u10). \tag{5}$$

If  $u$  ends with 1, then

$$(\rho_F(i), \rho_F(j)) = (u'00, u'000), \quad u' \text{ ending with } 2k \text{ zeroes, } k \geq 0. \tag{6}$$

Now consider  $(i, j)$  is such that  $(\rho_F(i - 2), \rho_F(j - 2)) = (u0, u01)$  (i.e., second case of Corollary 1). We have to apply the transducer to (5) and (6). From (5), we get

$$(\rho_F(i), \rho_F(j)) = (u', u'0), \quad u' \text{ ending with } 2k + 1 \text{ zeroes, } k \geq 0. \tag{7}$$

From (6), we get

$$(\rho_F(i), \rho_F(j)) = (u'01, u'001), \quad u' \text{ ending with } 2k \text{ zeroes, } k \geq 0. \tag{8}$$

Putting together (5), (6) and (7), we get exactly pairs of the kind  $(0v, v0)$ . These pairs are the ones exactly accepted from states  $f, g, h, x, y, z$  in the automaton from Fig. 5 (taking into account the symmetry on the two components). The pairs of the kind (8) are the ones accepted from state  $t$ .

It appears to be a painful task to consider the last case of Corollary 1 and to compare it with the words accepted by states  $m, s, u, v, w$ .  $\square$

#### 4. Redundant moves

We now investigate games whose sets of allowed moves are subsets of Wythoff's one, and whose set of  $\mathcal{P}$  positions is exactly Wythoff's sequence. We show that such a game does not exist. This means that there is no redundant move in Wythoff's game.

**Definition 4.** Denote by  $G_S$  an impartial game whose rules are given by a set of moves  $S$ . A move  $m$  is said to be *redundant* if  $G_S$  and  $G_{S \setminus \{m\}}$  have the same  $\mathcal{P}$  positions.

From any  $\mathcal{N}$  position  $(x, y)$  of Wythoff's game, there exists an allowed move  $m = (i, j)$  that leads to a  $\mathcal{P}$  position  $(a, b)$ , i.e., the relation  $(x - i, y - j) = (a, b)$  is satisfied. If the move  $m$  is unique, then it is said to be *forced* for the game. This definition can be naturally extended for any impartial game.

**Lemma 7.** In an impartial game  $G_S$ , a forced move is not redundant.

**Proof.** Let  $m = (i, j)$  be a forced move of  $G_S$ . There exist an  $\mathcal{N}$  position  $(x, y)$  and a  $\mathcal{P}$  position  $(a, b)$  such that  $(i, j) = (x - a, y - b)$ . Since  $m$  is the unique move for  $(x, y)$  to lead to a  $\mathcal{P}$  position of  $G_S$ , in the game  $G_{S \setminus m}$  there exists no move from  $(x, y)$  to a  $\mathcal{P}$  position of  $G_S$ . This means that in  $G_{S \setminus m}$  either  $(x, y)$  is a  $\mathcal{P}$  position or there exists a  $\mathcal{P}$  position  $(a', b') \neq (A_n, B_n), (B_n, A_n)$  such that  $(x, y)$  leads to  $(a', b')$ . In both cases, the set of  $\mathcal{P}$  positions of  $G_S$  differs from the one of  $G_{S \setminus m}$ .  $\square$

**Theorem 2.** *There is no redundant move in Wythoff's game.*

**Proof.** According to Lemma 7, it suffices to show that the set of the forced moves of Wythoff's game is identical to the set of the allowed moves  $M = \{(0, i), (i, 0), (i, i) : i \in \mathbb{Z}_{\geq 1}\}$ . The proof is divided into four parts.

*First part.* Let  $N_1$  be the set of the following  $\mathcal{N}$  positions of Wythoff's game:

$$N_1 = \{(0, i), (i, 0) : i \in \mathbb{Z}_{\geq 1}\}.$$

According to the sequence  $(A_n, B_n)$ , it is straightforward to see that each position of  $N_1$  leads to a unique  $\mathcal{P}$  position, which is  $(0, 0)$ . Hence each move  $m$  is forced, and it appears that the set of the forced moves from  $N_1$  is  $N_1$  itself.

*Second part.* Let  $N_2$  be the following set:

$$N_2 = \{(A_n, A_n) : n \in \mathbb{Z}_{\geq 1}\}.$$

Since  $n \geq 1$ , it appears that  $N_2$  is a set of  $\mathcal{N}$  positions of Wythoff's game. Let  $(A_n, A_n) \in N_2$ . Since  $(A_n, A_n)$  is an  $\mathcal{N}$  position, there exist a  $\mathcal{P}$  position  $(A_i, B_i)$  for some  $i$  and a move  $m$  such that  $(A_n, A_n) \xrightarrow{m} (A_i, B_i)$ . If  $i \geq n$ , then we have  $B_i > A_i \geq A_n$  since  $n \geq 1$ , which contradicts the existence of  $m$ . Hence we have  $i < n$  implying  $A_i \neq A_n$ . Since  $(A_k, B_k), k \geq 1$ , is a partition of  $\mathbb{Z}_{\geq 1}$ , we also have  $B_i \neq A_n$ . This means that  $m$  and  $i$  are unique: the move  $m$  is of the form  $(k, k)$  for some  $k$ , implying  $B_i - A_i = A_n - A_n = 0$ , and finally  $i = 0$ . Therefore,  $(A_n, A_n) \rightarrow (0, 0)$  for all  $n \geq 1$ , and there exists no other way to move to a  $\mathcal{P}$  position. We conclude that  $N_2$  is a set of forced moves of Wythoff's game.

*Third part.* Let  $N_3$  be the following set of positions:

$$N_3 = \{(A_n, A_n + 3) : n \in \mathbb{Z}_{\geq 4} \text{ and } A_n + 3 \neq B_j \ \forall j < n\}.$$

In view of Proposition 2, we know that there exists a unique  $\mathcal{P}$  position of Wythoff's game  $(A_n, B_n)$  such that  $B_n - A_n = 3$ . Therefore, since  $(A_3, B_3) = (4, 7)$  and  $(A_3, B_3) \notin N_3$ , the set  $N_3$  is a subset of  $\mathcal{N}$  positions of Wythoff's game.

Let  $(A_n, A_n + 3) \in N_3$ . There exist a  $\mathcal{P}$  position  $(A_i, B_i)$  for some  $i$  and a move  $m$  such that  $(A_n, A_n + 3) \xrightarrow{m} (A_i, B_i)$ . As in the previous case we have  $i < n$ , and since  $B_i \neq A_n + 3$ , this implies that the move  $m$  has the form  $(k, k)$  for some  $k$ . Hence the  $\mathcal{P}$  position  $(A_i, B_i)$  must satisfy  $B_i - A_i = 3$ , leading to  $(A_i, B_i) = (4, 7)$  according to the first terms of the sequence  $(A_n, B_n)$ . The move  $m = (A_n - 4, A_n + 3 - 7) = (A_n - 4, A_n - 4)$  is thus forced.

This proves that the set

$$M_3 = \{(A_n - 4, A_n - 4) : n \in \mathbb{Z}_{\geq 4} \text{ and } A_n - 4 \neq B_j - 7 \ \forall j \geq 1\}$$

is a set of forced moves of Wythoff's game. Since by Lemma 1, we have  $\{B_n\}_{n \geq 1} \subseteq \{A_n - 4\}_{n \geq 4}$ , we can deduce the following property for  $M_3$ :

$$\{(B_n, B_n) : n \in \mathbb{Z}_{\geq 1} \text{ and } B_n \neq B_j - 7 \ \forall j \geq 1\} \subseteq M_3.$$

Let  $n \geq 1$ . Since  $B_{i+1} - B_i \in \{2, 3\}$  by Remark 2, we have  $B_n = B_j - 7$  if  $j = n + 3$ . Hence we have

$$\{(B_n, B_n) : n \in \mathbb{Z}_{\geq 1} \text{ and } B_{n+3} - B_n \neq 7\} \subseteq M_3.$$

*Fourth part.* Before introducing the last set  $N_4$ , notice that for all  $n \geq 1$ , there exists an integer  $j$  such that  $A_j = B_n - 1$ . Indeed, there is no occurrence of two consecutive letters  $b$  in the Fibonacci word.

Let  $N_4$  be the following set of positions:

$$N_4 = \{(A_j + B_n, B_j + B_n) : n \in \mathbb{Z}_{\geq 1} \text{ such that } B_{n+3} - B_n = 7 \text{ and } j \text{ such that } A_j = B_n - 1\}.$$

We first prove that  $N_4$  is a subset of  $\mathcal{N}$  positions of Wythoff's game. Let  $(A_j + B_n, B_j + B_n)$  be a position belonging to  $N_4$ . Recall that  $\Delta_n(b)$  denotes the difference  $B_{n+1} - B_n$ . Since  $B_{n+3} - B_n = 7$

and by Remark 2, this implies that  $(\Delta_n(b), \Delta_{n+1}(b), \Delta_{n+2}(b))$  is a permutation of  $(2, 2, 3)$ . Once again by Remark 2 and since there are no consecutive occurrences of  $b$  in  $\mathcal{F}$ , the only allowed permutation is  $(2, 3, 2)$ . From this latter result, we also deduce that  $\Delta_n - 1(b) = 3$  since each letter  $b$  is preceded by a letter  $a$  in  $\mathcal{F}$ . Hence we get

$$\mathcal{F}(B_n - 1) = \mathcal{F}(B_n - 2) = a. \tag{9}$$

We now proceed in two steps:

- We show that  $A_j + B_n \in \{A_i\}_{i \geq 1}$ . By way of contradiction, assume that in the Fibonacci word  $\mathcal{F}$ , the letter occurring in position  $A_j + B_n$  is a  $b$ . This means that in  $\mathcal{F}$ , there exists a factor  $buba$ , where  $|u| = A_j - 1$ . Since each letter  $b$  is preceded by a letter  $a$  in  $\mathcal{F}$ , we can write  $u = u'a$ , where  $u'$  is a factor of length  $A_j - 2$ . By applying Lemma 2 for  $u'$ , we get  $|u'|_a = |\mathcal{F}_{A_j-2}|_a$ . Since  $A_j = B_n - 1$  and from (9), the previous equality gives:

$$|u'|_a = |\mathcal{F}_{A_j}|_a - 2. \tag{10}$$

Now by applying Lemma 2 to the factor  $ub$ , we get  $|ub|_a = |\mathcal{F}_{A_j}|_a$ . From this and since  $ub = u'ab$ , we have  $|u'|_a = |u|_a - 1 = |ub|_a - 1 = |\mathcal{F}_{A_j}|_a - 1$ , which contradicts (10).

- We show that  $B_j + B_n \in \{A_i\}_{i \geq 1}$ . According to Remark 4, it suffices to prove that  $\rho_F(B_j + B_n - 1)$  ends with a 0.

For the same reasons as in the proof of Lemma 4 and since  $B_{n+1} - B_n = 2$ , we get  $A_n = A_{n+1} - 1$ . By Lemma 4, we know that  $\rho_F(B_n - 1) = u101$ . Moreover from (4), we deduce that  $\rho_F(A_n - 1) = u10$ . Since  $A_j = B_n - 1$ , the following equalities thus hold:

$$\begin{aligned} \pi_F(\rho_F(A_j - 1)) &= \pi_F(\rho_F(B_n - 1)) - 1 \\ &= \pi_F(u101) - 1 \\ &= \pi_F(u100). \end{aligned}$$

We can now conclude about the  $F$ -representation of  $B_j + B_n - 1$ . Let  $u = u_\ell \cdots u_0$  with  $u_0 = 0$ :

$$\begin{aligned} \pi_F(\rho_F(B_j + B_n - 1)) &= \pi_F(\rho_F(B_n - 1)) + \pi_F(\rho_F(B_j - 1)) + 1 \\ &= \pi_F(u101) + \pi_F(\rho_F(A_j - 1)1) + 1 \quad \text{from (4)} \\ &= \pi_F(u101) + \pi_F(u1001) + 1 \\ &= \pi_F(u101) + \pi_F(u1010) \\ &= \sum_{i=0}^{\ell} u_i F_{i+3} + F_2 + F_0 + \sum_{i=0}^{\ell} u_i F_{i+4} + F_3 + F_1 \\ &= \sum_{i=0}^{\ell} u_i F_{i+5} + F_4 + F_2 \\ &= \pi_F(u10100). \end{aligned}$$

Then, since  $\{A_i\}_{i \geq 1}$  and  $\{B_i\}_{i \geq 1}$  partition of  $\mathbb{N}_{\geq 1}$ , and since  $A_j + B_n, B_j + B_n$  both belong to  $\{A_i\}_{i \geq 1}$ , then the position  $(A_j + B_n, B_j + B_n) \notin (A_i, B_i)_{i \geq 1}$ . This means that  $(A_j + B_n, B_j + B_n)$  is an  $\mathcal{N}$  position.

Therefore, there exist a  $\mathcal{P}$  position  $(A_i, B_i)$  for some  $i$  and an allowed move  $m$  of Wythoff's game such that  $(A_j + B_n, B_j + B_n) \xrightarrow{m} (A_i, B_i)$ . If the move  $m$  has the form  $(0, k)$  or  $(k, 0)$ , then we have either

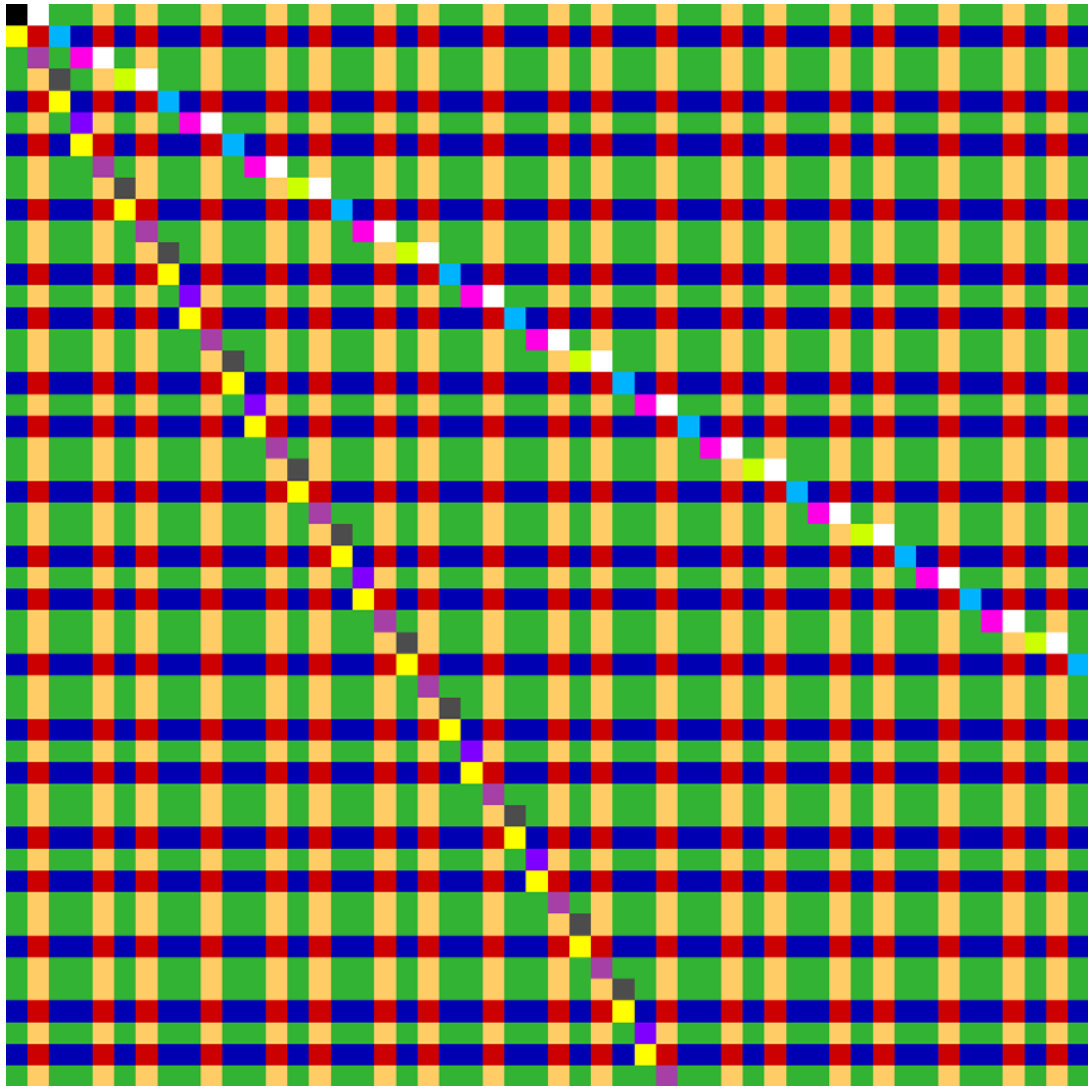

Fig. 7. Upper-left corner of  $\varphi^\omega(a)$  where the 13 symbols have been replaced with different colors. (Colors are only available on the Web version of this article.)

$$A_j + B_n = A_i \quad \text{and} \quad B_j + B_n > B_i \tag{11}$$

or

$$B_j + B_n = A_i \quad \text{and} \quad A_j + B_n > B_i. \tag{12}$$

The first equality of (11) implies  $j < i$  since the sequence  $\{A_i\}_{i \geq 1}$  is increasing. The second inequality of (11) can also be written as  $A_i + j > B_i$ , contradicting the previous remark (remember that  $B_i - A_i = i$  for all  $i$ ). Replacing  $B_n$  by  $A_i - B_j$  in the second inequality of (12) leads to  $A_j + A_i > B_j + B_i$ , which is not correct since  $B_i > A_i$  for all  $i$ .

Hence the move  $m$  has the form  $(k, k)$  and is unique since there exists a unique  $\mathcal{P}$  position  $(A_i, B_i)$  whose difference  $B_i - A_i$  equals  $(B_j + B_n) - (A_j + B_n) = B_j - A_j$ . More precisely,  $(A_i, B_i) = (A_j, B_j)$  and the move  $m = (B_n, B_n)$  is forced. Therefore the set

$$M_4 = \{(B_n, B_n) : n \in \mathbb{Z}_{\geq 1} \text{ and } B_{n+3} - B_n = 7\}$$

is a set of forced moves.

Putting together all the previous results, we have that the set

$$N_1 \cup N_2 \cup \{(B_n, B_n) : n \in \mathbb{Z}_{\geq 1}\}$$

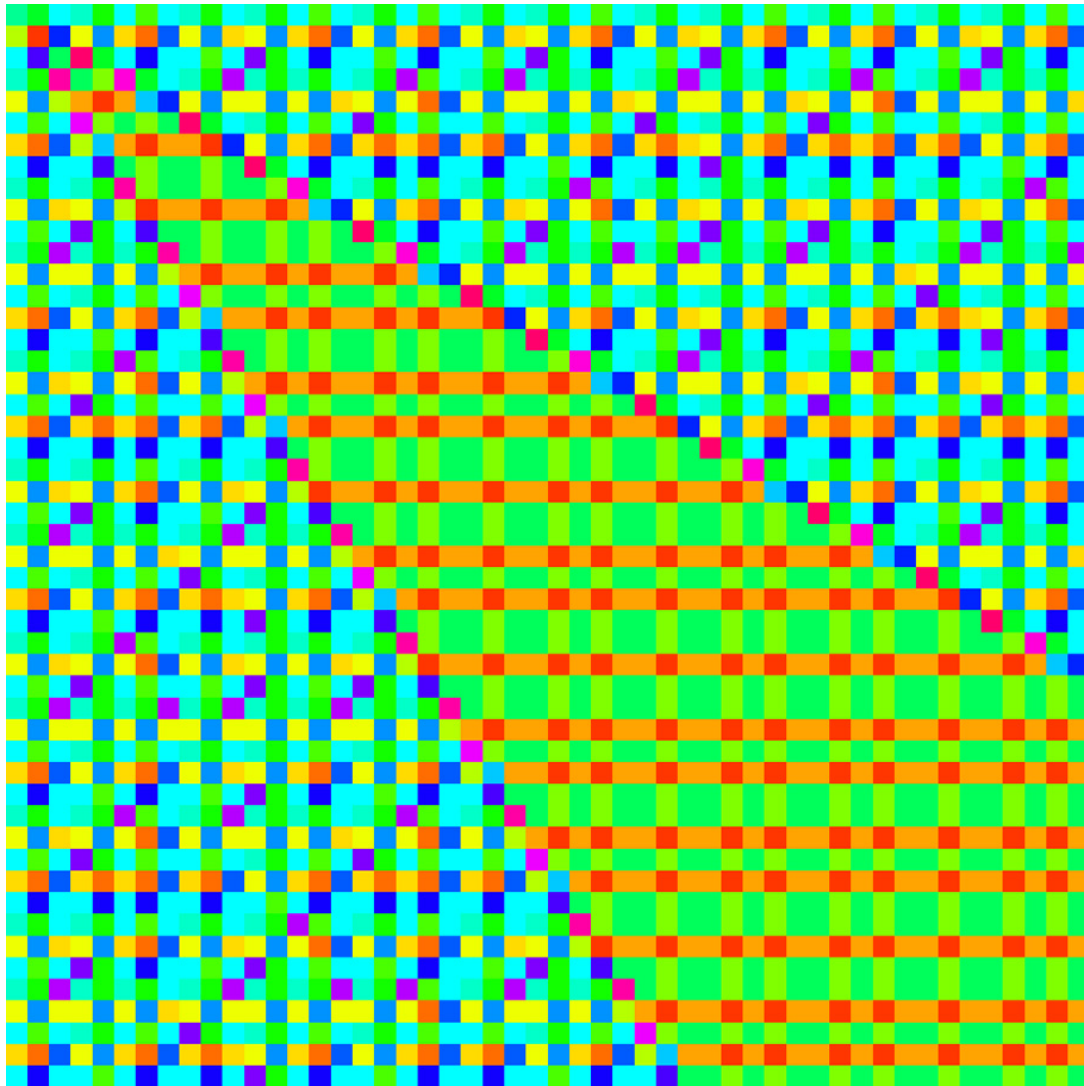

**Fig. 8.** Upper-left corner of  $\psi^\omega(a)$  where the 26 symbols have been replaced with different colors. (Colors are only available on the Web version of this article.)

contains forced moves of Wythoff's game only. Moreover, this set defines exactly the allowed moves of Wythoff's game. This concludes the proof.  $\square$

### 5. Open problems

**Question 1.** The above results give all the extensions and restrictions of Wythoff's game that have the sequence  $(A_n, B_n)$  as a set of  $\mathcal{P}$  positions. Does there exist a variant of Wythoff's game which is neither an extension nor a restriction, and having also this sequence as a set of  $\mathcal{P}$  positions?

**Question 2.** What about these characterizations when considering the *generalized Wythoff game* of parameter  $s$  (defined in [13])? It appears that for  $s > 1$ , there are restrictions preserving the set of  $\mathcal{P}$  positions.

**Question 3.** In view of the bi-dimensional morphisms that we produced for Wythoff's sequence and the  $W$  matrix, does there exist such a morphism producing the Grundy values of Wythoff's game?

### Appendix A

In this appendix, we give in Figs. 7 and 8 color to the generated fixed points.

## References

- [1] J.-P. Allouche, J.O. Shallit, *Automatic Sequences: Theory, Applications, Generalizations*, Cambridge University Press, Cambridge, 2003.
- [2] E.R. Berlekamp, J.H. Conway, R.K. Guy, *Winning Ways*, 2nd edition, A K Peters, Wellesley, MA, 2001.
- [3] V. Bruyère, G. Hansel, Bertrand numeration systems and recognizability, *Theoret. Comput. Sci.* 181 (1997) 17–43.
- [4] A. Cobham, Uniform tag sequences, *Math. Systems Theory* 6 (1972) 164–192.
- [5] I.G. Connell, A generalization of Wythoff's game, *Canad. Math. Bull.* 2 (1959) 181–190.
- [6] E. Duchêne, S. Gravier, Geometrical extensions of Wythoff's game, *Discrete Math.* 309 (2009) 3595–3608.
- [7] E. Duchêne, A.S. Fraenkel, S. Gravier, R.J. Nowakowski, Another bridge between Nim and Wythoff, *Australas. J. Combin.* 44 (2009) 43–56.
- [8] E. Duchêne, M. Rigo, A morphic approach to combinatorial games: The Tribonacci case, *Theor. Inform. Appl.* 42 (2008) 375–393.
- [9] A. Fink, R.J. Nowakowski, A.N. Siegel, D. Wolfe, Toppling conjectures, *Games of No Chance 4*, in press.
- [10] A.S. Fraenkel, Complexity, appeal and challenges of combinatorial games, *Theoret. Comput. Sci.* 313 (2004) 393–415.
- [11] A.S. Fraenkel, Euclid and Wythoff games, *Discrete Math.* 304 (2005) 65–68.
- [12] A.S. Fraenkel, Heap games, numeration systems and sequences, *Ann. Comb.* 2 (1998) 197–210.
- [13] A.S. Fraenkel, How to beat your Wythoff games' opponent on three fronts, *Amer. Math. Monthly* 89 (1982) 353–361.
- [14] A.S. Fraenkel, M. Lorberbom, Nimhoff games, *J. Combin. Theory Ser. A* 58 (1991) 1–25.
- [15] A.S. Fraenkel, E. Reisner, The game of End-Wythoff, games of No Chance III, in: M.H. Albert, R.J. Nowakowski (Eds.), *Proc. BIRS Workshop on Combinatorial Games, July 2005, Banff, Alberta, Canada*, in: *Math. Sci. Res. Inst. Publ.*, vol. 56, Cambridge University Press, Cambridge, 2009, pp. 329–347.
- [16] C. Frougny, On the sequentiality of the successor function, *Inform. and Comput.* 139 (1997) 17–28.
- [17] P. Lecomte, M. Rigo, Numeration systems on a regular language, *Theory Comput. Syst.* 34 (2001) 27–44.
- [18] M. Lothaire, *Combinatorics on Words*, Cambridge Math. Lib., Cambridge University Press, Cambridge, 1997.
- [19] A. Maes, *Morphic predicates and applications to the decidability of arithmetic theories*, University of Mons-Hainaut, PhD thesis, 1999.
- [20] M. Rigo, A. Maes, More on generalized automatic sequences, *J. Autom. Lang. Comb.* 7 (2002) 351–376.
- [21] O. Salon, Suites automatiques à multi-indices, in: *Séminaire de Théorie des Nombres, Bordeaux, 1986–1987*, exposé 4.
- [22] W.A. Wythoff, A modification of the game of Nim, *Nieuw Arch. Wiskd.* 7 (1907) 199–202.
- [23] E. Zeckendorf, Représentation des nombres naturels par une somme des nombres de Fibonacci ou de nombres de Lucas, *Bull. Soc. Roy. Sci. Liège* 41 (1972) 179–182.